

P O W E R

MEDICAL SAFETY POWER SOLUTION GUIDE

2024

POWER FOR
A BETTER FUTURE



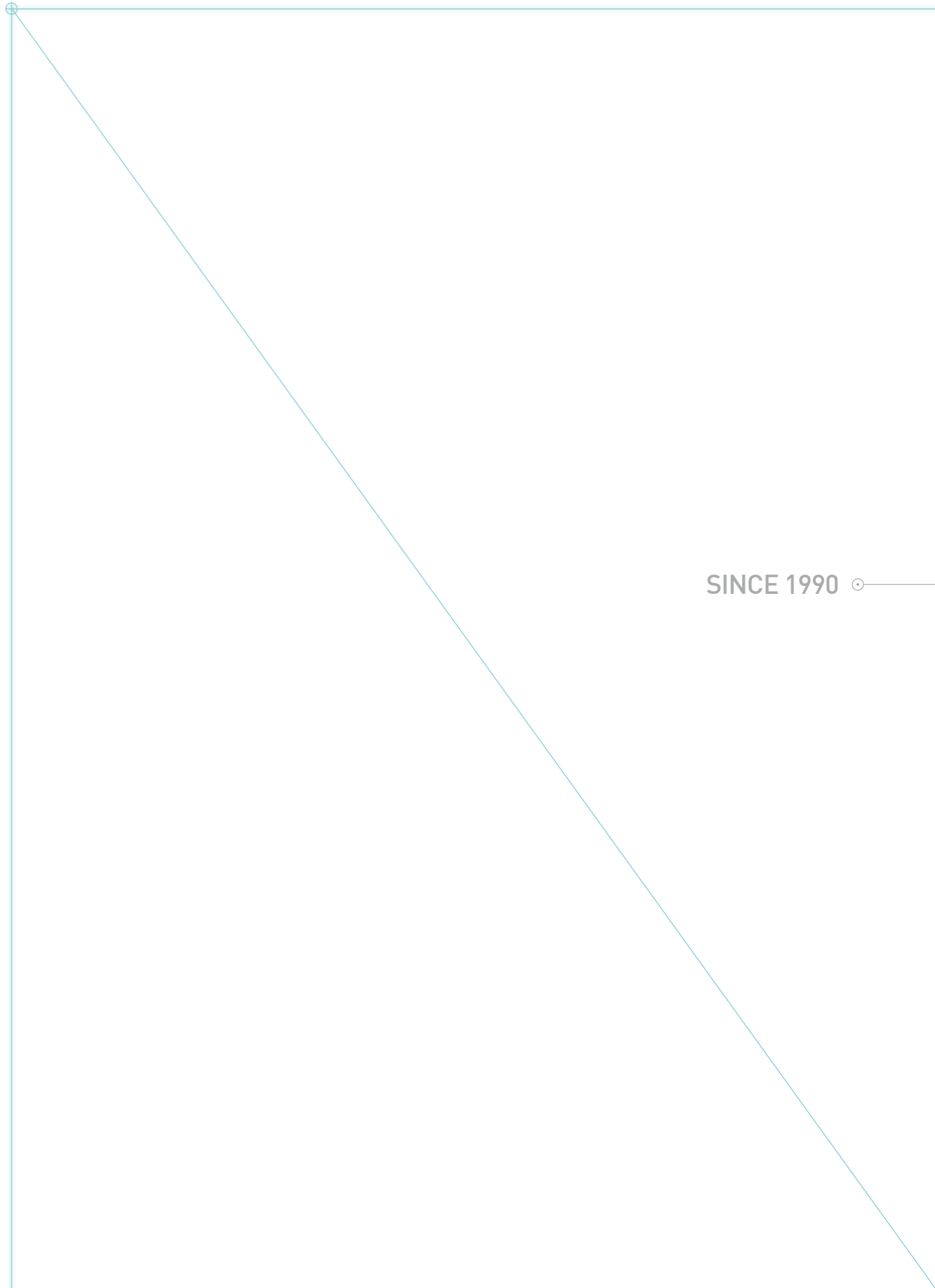

SINCE 1990





PREFACE

MEDICAL SAFETY POWER SOLUTIONS ENGINEERED BY MINMAX

MINMAX has an extensive history and experience with the design of medical safety DC-DC converters and AC-DC power supplies for demanding applications in both medical and healthcare instrumentation that requires medical safety and a reinforced insulation system. MINMAX offers a large standard range of high-isolation and reinforced insulated medical safety DC-DC converters with a power ranging from 1 to 20 W and AC-DC power supplies with a power ranging from 24 to 60 W.

Given the requirements for medical/healthcare applications for I/O isolation, MINMAX Medical Safety Power Solutions are rated from 3000 to 5000 VAC and possess reinforced insulation and a low leakage current for operator protection (2xMOOP) or patient protection (2xMOPP).

All medical safety products meet the latest medical safety standards (ANSI/AAMI ES 60601-1 and IEC/EN 60601-1 3rd edition) and are approved for nominal working voltages of 250 Vrms or higher.

MINMAX medical safety DC-DC converters and AC-DC power supplies offer cost-effective power solutions for demanding medical and healthcare applications in dental chairs, oral care equipment, infusion pumps, medical assist devices, medical oxygen monitors, medical carts, CT scanning, ultrasound, and many pieces of medical auxiliary equipment.

CONTENTS

MEDICAL SAFETY INTRODUCTION AND APPLICATIONS

History of the Editions of Medical Safety Standard IEC 60601	05
Changes from the 2 nd Edition to the 3 rd Edition of the IEC 60601-1 Standard	05-06
Isolation Voltage and Safety Distance in the 3 rd Edition of the IEC 60601-1 Standard	06-07
Leakage Current in the 3 rd Edition of the IEC 60601-1 Standard	07
Insulation Type	08
Structure of the Medical Insulation System	08-09
Medical EMC Standards	09-10
Cost vs. Risks to Safety	10
HIGHLIGHTED PERFORMANCE OF MEDICAL SAFETY PRODUCTS	11-16

MINMAX MEDICAL SAFETY POWER SOLUTIONS

Successful Application	17
Medical Safety Products Overview	18
Medical Safety 1-20W DC-DC Converters	19-24
Medical Safety 24-60W AC-DC Power Supplies	25

MEDICAL SAFETY INTRODUCTION AND APPLICATIONS

HISTORY OF THE EDITIONS OF MEDICAL SAFETY STANDARD IEC 60601

- Medical Safety Standard IEC 60601 was first published in 1977; the internationally accepted and approved IEC 60601 standard is the fundamental document that addresses many risks and has been developed to help alleviate safety issues associated with electrical medical and healthcare equipment.
- The standard consists of four distinct parts: the base standard (60601-1), collateral standards (60601-1-x), particular standards (60601-2-x), and performance standards (60601-3-x). The base standard, IEC 60601-1, has been adopted in most major countries as a national standard.
- The 3rd edition of the approved IEC 60601-1 medical safety standard was first published by the IEC in 2005 (IEC 60601:2005). The IEC 60601 standard was adopted by the European Union in 2006 and published as EN 60601-1:2006. The 3rd edition standard was also published in 2006 by the USA but is different from the 2nd edition published by UL. The 3rd edition was published by the American Association for Medical Instrumentation (AAMI) and published as ANSI/AAMI ES 60601:2006. Canada published this medical safety standard in 2008 as CAN/CSA 60601:2008.

The 3rd edition of Medical Safety Standard IEC 60601 went into effect at different times depending on region.

- 1997** 1st EDITION published by IEC
- 1988** 2nd EDITION published by IEC
- 2005** 3rd EDITION published by IEC

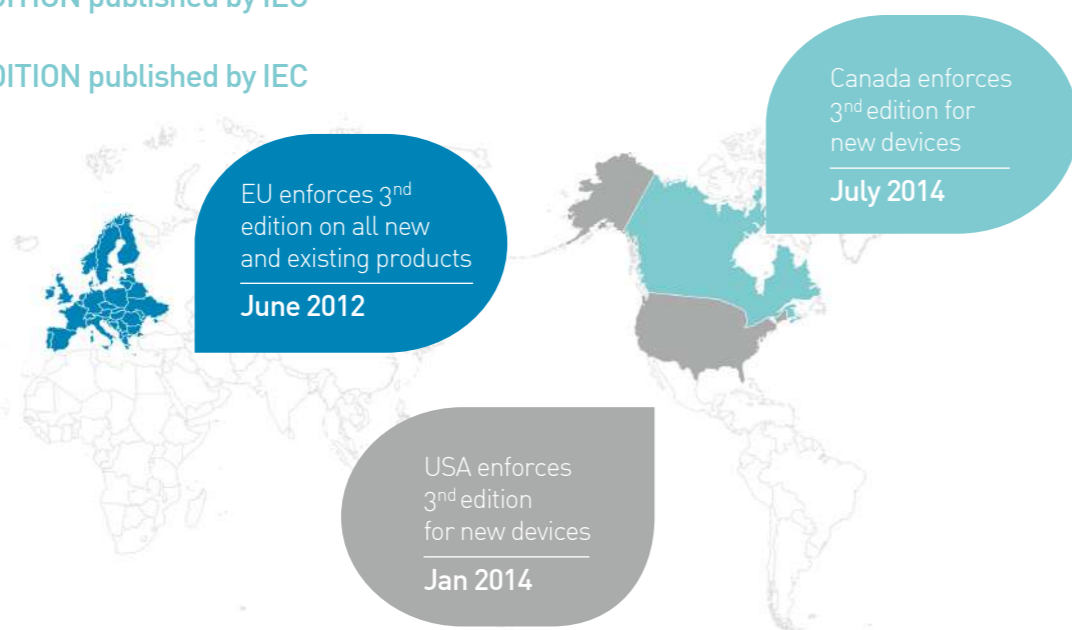

HISTORY OF THE EDITIONS OF MEDICAL SAFETY STANDARD IEC 60601

- In Europe, the 2nd edition of the IEC 60601-1 standard was withdrawn; all products including both new products introduced to the market and products already on sale need to be certified under the 3rd edition of the EN 60601-1 standard before the cessation date. The original cessation date for the 2nd edition in the United States is July 1, 2013. The FDA announced an extension to give US medical device designers a slight reprieve, setting the updated transition date to December 31, 2013, and the effective date for the released 3rd edition was January 1, 2014. Unlike the EU, the FDA only requires that new products after this date need to be certified to the ANSI/AAMI ES 60601-1 standard; existing products do not.
- In Canada, the original cessation date for the 2nd edition was delayed, as in the USA, with an updated transition date of June 30, 2014. The effective date for the released 3rd edition was July 1, 2014. However, only new products after this date need to satisfy the 3rd edition.
- All MINMAX medical safety AC-DC power supplies and medical safety DC-DC converters have been certified to the approved 3rd edition standard (with twice the means of protection for the majority of power supplies) and also tested against the 2nd edition.

CHANGES FROM THE 2nd EDITION TO THE 3rd EDITION OF THE IEC 60601-1 STANDARD

- In the 2nd edition of the IEC 60601-1 standard, the guidelines need to be applied when the electrical medical and healthcare equipment was within the "patient vicinity," defined as a 6-ft. radius around the patient.
- There were three categories of increasing severity:also tested against the 2nd edition.

- Type.B | body |** An applied part that is not in electrical contact with the patient.
- Type.BF | body floating |** An applied part that is not in electrical contact with the patient.
- Type.CF | cardiacfloating |** An applied part that is electrically connected to the heart of the patient.

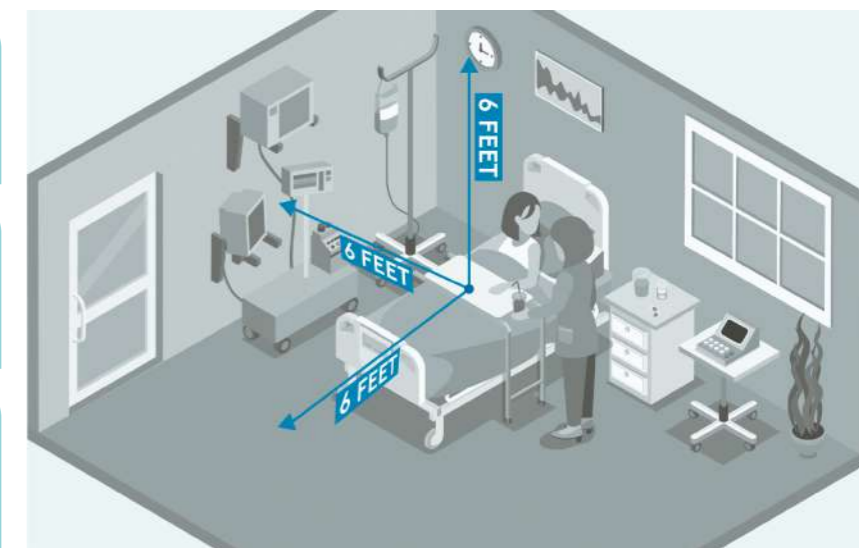

CHANGES FROM THE 2nd EDITION TO THE 3rd EDITION OF THE IEC 60601-1 STANDARD

- The 2nd edition of the IEC 60601-1 standard only addresses the basic safety issues for protection from any electrical, mechanical, radiation, and thermal hazards. However, it did not require devices to remain functional; a fail-safe was adequate and did not take the essential performance of the device into account in a pass/fail result test. Therefore, the 3rd edition of the IEC 60601-1 standard introduces specifications for “essential performance” that require medical/healthcare equipment to continue functioning throughout the test process.
- As medical safety AC-DC power supplies and medical safety DC-DC converters have significantly played a crucial role in certified electrical medical and healthcare equipment, the 3rd edition of the IEC 60601-1 standard introduces new concepts such as the essential performance of equipment and distinguishes protecting the equipment’s operator and the patient by **Means of Operator Protection (MOOP)** and **Means of Patient Protection (MOPP)** classification in terms of the separation safety distance, insulation schemes, and dielectric strength requirements.
- The classification determined the mandated or allowed types of levels of isolation, insulation, creepage, air clearance, and leakage current that operators and patients may come into contact with.

ISOLATION VOLTAGE AND SAFETY DISTANCE IN THE 3rd EDITION OF THE IEC 60601-1 STANDARD

- The 3rd edition of the approved IEC 60601-1 safety standard specified that the safety distance for the minimum creepage, air clearance, and isolation voltage must be met in order to avoid risks and to ensure freedom from dangerous energy shocks due to any electrical shocks and excess energy hazards, transient voltage spikes, insulation breakdown of the power architecture, mechanical damage, ignition, fires, shorts developing between PCB tracks and across air gaps, arcing, and ground loops, which comply with the limited leakage current during normal and single-fault conditions.

The level requirement for the isolation voltage depends on the insulation type, the working voltage, and the degree of pollution, and the insulation barriers must have undergone a high-voltage test.

From our standpoint at MINMAX, we believe that the power supplies for medical and healthcare equipment should provide the highest degree of protection; therefore, our medical safety DC-DC converters and AC-DC power supplies have 2xMOPP/2xMOOP from the primary side to the secondary side (mains AC to low-voltage DC). This gives medical/healthcare equipment designers flexibility and assurance that there are primary and secondary reinforced insulation barriers in the medical power architecture to ensure long-term safety.

Insulation	MOOP			MOPP		
	Air Clearance	Creepage Distance	Test Voltage	Air Clearance	Creepage Distance	Test Voltage
Basic 1 x MOP	2.0 mm	3.2 mm	1500 VAC	2.5 mm	4.0 mm	1500 VAC
Double or Reinforced 2 x MOP	4.0 mm	6.4 mm	3000 VAC	5.0 mm	8.0 mm	4000 VAC

| Insulation test voltages based on 250 VAC working voltage | MOP = Means of protection | MOOP = Means of operation protection | MOPP = Means of patient protection |

ISOLATION VOLTAGE AND SAFETY DISTANCE IN THE 3rd EDITION OF THE IEC 60601-1 STANDARD



LEAKAGE CURRENT IN THE 3rd EDITION OF THE IEC 60601-1 STANDARD

- Whether the product is considered MOOP or MOPP, the leakage-current requirements must be met.
- A further change between the 2nd and 3rd editions is related to the Earth leakage-current requirements.
- The leakage current needs to comply with a limit value to avoid risks and ensure freedom from dangerous energy shocks due to any electrical shock and excess energy hazards, transient voltage spikes, insulation breakdown of the power architecture, mechanical damage, ignition, fire, shorts developing between PCB tracks, air gaps, arcing, and ground loops that the operator or patient may come into direct contact during normal and single-fault conditions.
- Leakage-current tests are designed to simulate a human body coming into contact with different parts of the medical/healthcare equipment. The measured leakage-current values should comply with the acceptable limits.

Earth leakage current	Current flowing in the earth conductor.					
Enclosure leakage current	Current flowing to earth via the patient from the enclosure.					
Patient leakage current	Current flowing to earth via the patient from an applied part.					
Patient auxiliary current	Current flowing between two applied parts.					
Leakage Current	TYPE B		TYPE BF		TYPE CF	
	NC	SFC	NC	SFC	NC	SFC
Earth leakage current general	500 μA*	1000 μA	500 μA*a	1000 μA*	500 μA*	1000 μA
Enclosure leakage current	100 μA	500μA*	100μA	500μA*	100μA	500μA*
Patient leakage current AC	100 μA	500μA	100μA	500μA	10μA	50μA
Patient auxiliary current DC	10 μA	50μA	10μA	50μA	10μA	50μA

| NC = Normal Conditions|

| SFC = Single Fault Conditions|

| *The maximum Earth and enclosure leakage current for patient care equipment in the US is 300 μA.|

| [1] "Enclosure Leakage Current" changed to "Touch Leakage Current" in the 3rd edition of the IEC 60601-1 standard|

INSULATION TYPE

- The five different types of insulation grades are listed below.

Functional Insulation	Insulation that is necessary only for the correct functioning of the equipment and does not provide any protection against electric shock.
Basic Insulation	Insulation applied to live parts to provide protection against electric shock.
Supplementary Insulation	Independent insulation applied in addition to basic insulation in order to provide protection against electric shock in the event of a failure of basic insulation.
Double Insulation	Insulation comprising both basic insulation and supplementary insulation.
Reinforced Insulation	Single insulation system applied to live parts which provide a degree of protection against electric shock equivalent to double insulation.

STRUCTURE OF THE MEDICAL INSULATION SYSTEM

- The figure below shows the insulation system structure and two insulation barriers that provide two Means of Protection (MOP) that must be present within medical/healthcare systems.
- Two insulation barriers are required to ensure that the applied part, which includes both patients and operators, is isolated and protected from dangerous energy shocks due to any electrical shocks and excess energy hazards, transient voltage spikes, insulation breakdown of the power architecture, mechanical damage, ignition, fire, shorts developing between PCB tracks, air gaps, arcing, and ground loops and complies with the limited leakage current during normal and single-fault conditions.
- Within the electrical safety area, medical safety approval requires equipment to implement two Means of Protection (MOP) such that if a failure occurs within one area, a second mechanism safeguards the operator and/or patient against dangerous energy shocks from any electrical shocks and excess energy hazards, transient voltage spikes, and insulation breakdown of the power architecture.

MINMAX medical safety AC-DC power supplies and medical safety DC-DC converters have been approved to the new 3rd edition of the IEC 60601-1 standard with a reinforced insulation level. Further, all medical safety AC-DC power supplies provide 2xMOPP and are suitable as the **primary reinforced insulation barrier**. All medical safety DC-DC converters provide 2xMOPP or 2xM0OP and are suitable as the **secondary reinforced insulation barrier** of the insulation system structure to ensure the long-term safety of operators/patients.

STRUCTURE OF THE MEDICAL INSULATION SYSTEM

- Medical/Healthcare Insulation System

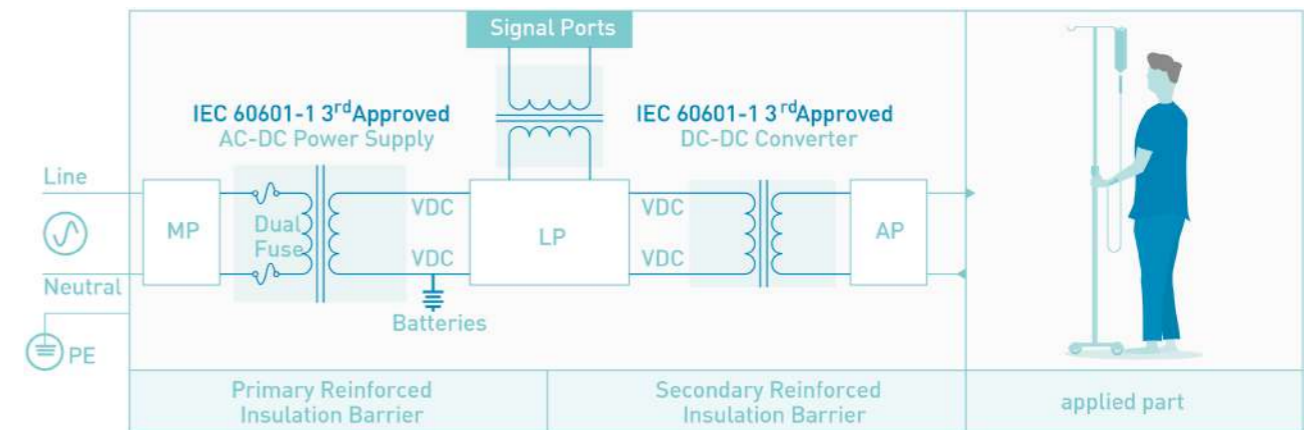

- MP : Mains Part |
- LP : Live Part = Non Applied Part Electronic Circuit |
- AP : Applied Part = Applied Part Electronic Circuit |

MEDICAL EMC STANDARDS

- All MINMAX medical safety AC-DC power supplies and DC-DC converters undergo 4th edition medical EMC (Emission + Immunity) testing of LIFE-SUPPORTING ME EQUIPMENT to help us provide as much information as possible during the design-in process to ensure that medical/healthcare equipment comply with EN 50155: 2009+AI for EMI (Electromagnetic Interference) and EN 60601-1-2: 2015 for EMS (Electromagnetic Susceptibility).

- EMC Test Level of Medical Safety DC-DC Converters

Phenomenon	EN 60601-1 Reference Clause	Reference Standard	MINMAX Test Level of Medical DC-DC Converters			
			Frequency Range	Quasi-peak	Average	
EMI	EN 55011	EN 55011	Group 1 Class A	0.15 – 0.5MHz	Quasi-peak 79 dBuV	Average 66 dBuV
				0.5 – 5.0MHz	Quasi-peak 73 dBuV	Average 60 dBuV
				5.0 – 30MHz	Quasi-peak 73 dBuV	Average 60 dBuV
Radiated Emission	EN 55011	EN 55011	Group 1 Class A	30 – 230MHz	40 dBuV/m	
				230 – 1000MHz	47 dBuV/m	
ESD Test	EN 60601-1-2	IEC 61000-4-2	Air Discharge : ±15KVDC Contact Discharge ±8KVDC			
Radiated Immunity (RS)	EN 60601-1-2	IEC 61000-4-3	80 to 2700MHz : 10V/m 385 to 6000MHz 9-28 V/m			
Electrical Fast Transient (EFT)	EN 60601-1-2	IEC 61000-4-4	L1, L2, L1+L2 : ±2KVDC			
Surge Immunity Test	EN 60601-1-2	IEC 61000-4-5	L1 to L2 : ±2KVDC			
Conducted Immunity (CS)	EN 60601-1-2	IEC 61000-4-6	0.15 to 80MHz : 10Vrms ISM Frequency : 6 Vrms			
Power Frequency Magnetic Field (PFMF)	EN 60601-1-2	IEC 61000-4-8	X, Y, Z axis : 30 A/m			

MEDICAL EMC STANDARDS

• EMC Test Level of Medical Safety AC-DC Power Supplies

Phenomenon		EN 60601-1 Reference Clause	Reference Standard	MINMAX Test Level of Medical DC-DC Converters		
EMI	Conducted Emission	EN 55011	EN 55011	Group 1 Class A	0.15 – 0.5MHz	Quasi-peak 66-56 dBuV Average 56-46 dBuV
					0.5 – 5.0MHz	Quasi-peak 56 dBuV Average 46 dBuV
					5.0 – 30MHz	Quasi-peak 60 dBuV Average 50 dBuV
Radiated Emission	EN 55011	EN 55011	Group 1 Class A	30 – 230MHz	30 dBuV/m	
				230 – 1000MHz	37 dBuV/m	
EMS	ESD Test	EN 60601-1-2	IEC 61000-4-2	Air Discharge : ±15KVDC Contact Discharge ±8KVDC		
	Radiated Immunity (RS)	EN 60601-1-2	IEC 61000-4-3	80 to 2700MHz : 10V/m 385 to 6000MHz 9-28 V/m		
	Electrical Fast Transient (EFT)	EN 60601-1-2	IEC 61000-4-4	L, N, L+N : ±2KVDC		
	Surge Immunity Test	EN 60601-1-2	IEC 61000-4-5	L to N : ±2KVDC		
	Conducted Immunity (CS)	EN 60601-1-2	IEC 61000-4-6	0.15 to 80MHz : 10Vrms ISM Frequency : 6 Vrms		
	Power Frequency Magnetic Field (PFMF)	EN 60601-1-2	IEC 61000-4-8	X, Y, Z axis : 30 A/m		
	Voltage Dips	EN 60601-1-2	IEC 61000-4-11	Dips : 100% Reduction for 0.5 cycle at 50 Hz 100% Reduction for 1 cycle at 50 Hz 30% Reduction for 25/30 cycle at 50/60 Hz		
Short Interruptions	Interruptions : 100% Reduction for 250/300 cycle at 50/60 Hz					

COST VS. RISKS TO SAFETY

- Although the 3rd edition of the IEC 60601-1 standard offers medical/healthcare equipment manufacturers more options related to the choice of power supply, the upcoming question of risk vs. cost must be considered, i.e., a cheaper power supply with a lower performance to save a few dollars versus a power supply with higher specifications and safety certification that might cost more but reduce the risk as much as possible. After all, if you get it wrong in medical device design, it can limit your market, compromise your brand, and severely delay regulatory approval or worse.
- As a result, the specifications of medical safety power supplies that are approved at the IEC/EN 60601-1 standard and comply with Means of Protection (MOP) is preferred for medical/healthcare equipment manufacturers.

HIGHLIGHTED PERFORMANCE OF MEDICAL SAFETY PRODUCTS

Ultra-wide Input Voltage Range

- Medical/Healthcare Insulation System



• Example : MIW06-24S12M

Input Voltage Range
9-18, 18-36, 36-75VDC

Fully Regulated Output Voltage
5, 12, 15, ±12VDC

Fully Vacuum Encapsulated to Save Your System

- For the electromagnetic susceptibility and environmental physical stress interference which are protected from a comprehensive protection capabilities.



Reinforced Insulation & 5KVAC Isolation for System Safety

- The 5KVAC I/O isolation with reinforced insulation and vacuum encapsulated creates a solid electrical barrier which to protect sensitive circuit load from noise, electromagnetic disturbances, power bus fluctuation, avoid the risk and ensure freedom dangerous energy shock from any electric shock and excess energy hazards, transient voltage spike, insulation breakdown of power architecture, mechanical damage, ignition, fire and short developing between PCB tracks, air gaps, arcing and ground loop that provide safety on long-term operation of medical/ healthcare equipment.

Please refer to the "Isolation Voltage and Safety Distance in the 3rd Edition of the IEC 60601-1 Standard & Leakage Current in the 3rd Edition of the IEC 60601-1 Standard & Insulation Type" on Page 04 & 05 & 06 for more information.

* Example : MIW06-24S12M

8mm Creepage & Clearance with 2xMOPP Level

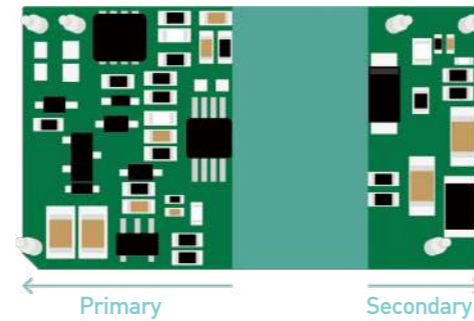

Isolation 5KVAC/60sec with Reinforced Insulation
Low Leakage Current < 2uA
Low I/O Isolation Capacitance 40pF max.

Wider Operating Ambient Temperature Range

- Wider operating temp. range by latest thermal management technology and fully vacuum encapsulated.

Wider Operating Temp. Range

-40 to +95°C without air-forced fan or heatsink cooling

Storage Temp. Range

-50 to +125°C

Operating Humidity

95% rel. H

* Example : MIW06-24S12M

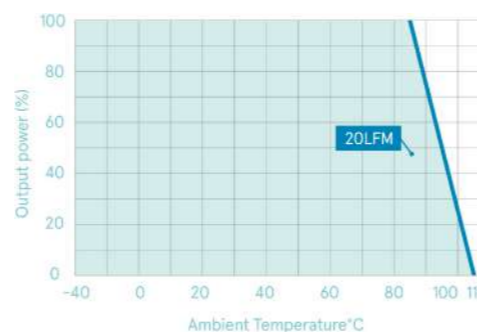

ECO Technology

Green Design for Higher Full Range Efficiency

- High efficiency for whole output load, input line & ambient temp. range by latest green design technology helps to energy saving, thermal management, minimize the temp. rise and size miniaturization.

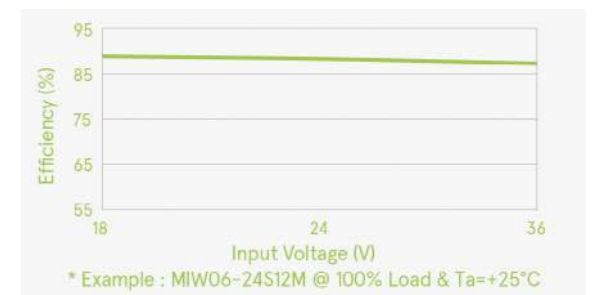
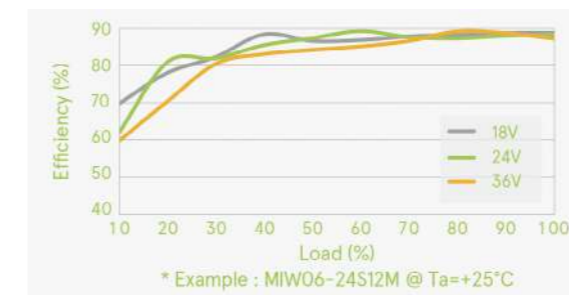

Green Design for Energy Saving, Minimize Temperature Rise

- Ultra low no-load power consumption by latest green design technology helps to improve and minimize the temp. rise (avoid thermal problem), energy saving and prolong the battery life.

Very Low No Load Input Current 5mA @ 24Vin
Very Low No Load Power Consumption 0.12Watt @ 24Vin

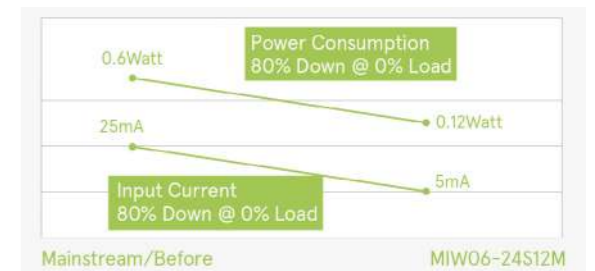

Green Design for No Min. Load / Dummy Load Requirement

- With high stability feedback loop design, the MINMAX medical safety power solutions may not oscillate in no-load or light-load condition.



Power Your System Precisely

- Setting Accuracy $\pm 1\%$ Vom | Line Regulation $\pm 0.5\%$ | Load Regulation $\pm 0.5\%$ | High Transient Response | Low Temperature Coefficient |
- The output voltage will still keep with excellent accuracy, even though the input voltage, output current and ambient temp. of the system are unstable.
- The output voltage of mainstream products may undershoot and overshoot obviously during the load changes. MINMAX medical safety power solutions are still keep with rated output voltage precisely.

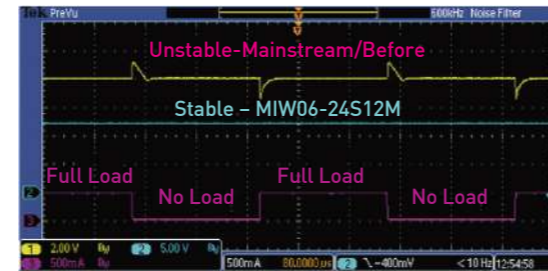

Faster Start-up Time without Overshoot

- The start-up time of MIW06M decreases from 250mS to 20mS which helps to avoid any system timing failure caused by long start-up time. Faster start-up time without overshoot ensures the safety of your system.

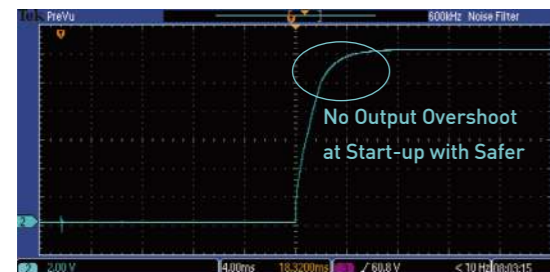
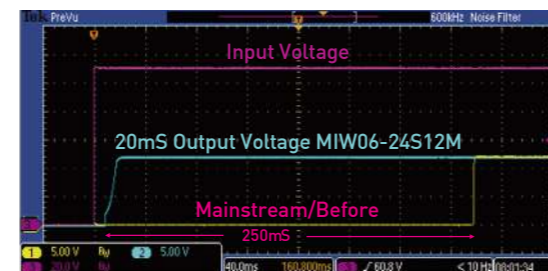

Example : MIW06-24S12M



Example : Mainstream/Before

Superior Load Driving Capability

- MINMAX medical safety power solutions have superior load driving capability which can drive your system during very low voltage and even zero voltage output without start-up failure.

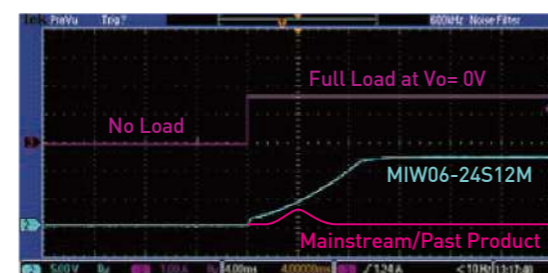

Excellent EMC Performance

- Excellent EMI performance by upgraded noise filtering technology helps to improve overall system EMI performance on conduction and radiation emission.
- No external component needed for conducted emission meets EN 55011 Class A.
- Only few peripheral components needed for radiated emission meets EN 55011 Class B.

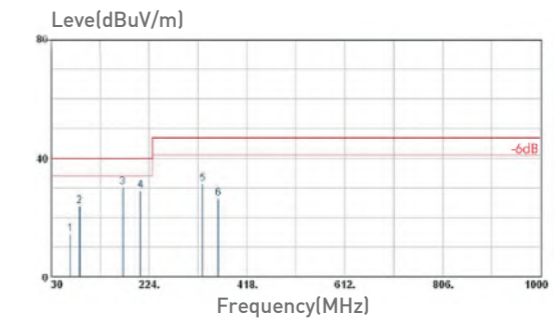
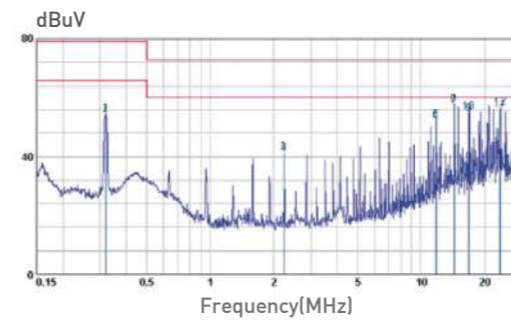

- Excellent EMS performance by upgraded noise immunity technology helps to improve overall system EMS performance on ESD, Surge, EFT, RS, CS and PFMF.
- Only one E-cap. needed for $\pm 2KV$ surge immunity by IEC 61000-4-5 with criteria A.
- Only one E-cap. needed for $\pm 2KV$ EFT immunity by IEC 61000-4-4 with criteria A.

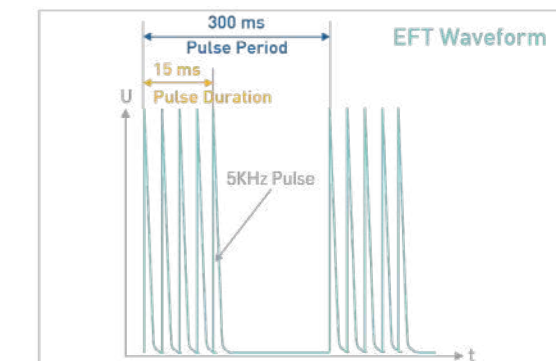
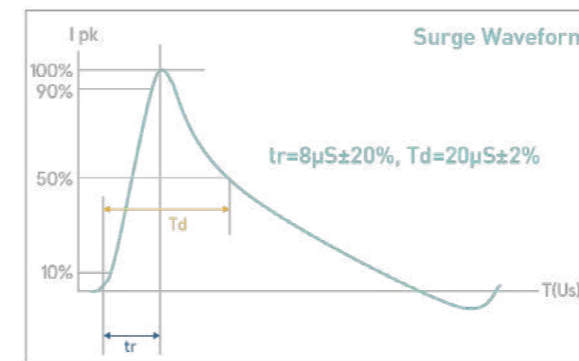

* Please refer to the "Medical EMC Standards" on Page 09 & 10 for more information.

Lower Ripple & Noise

- Small Ripple & Noise for whole output load, input line & ambient temp. range by upgraded noise filtering technology helps to reduce the peripheral components needed and noise interference.

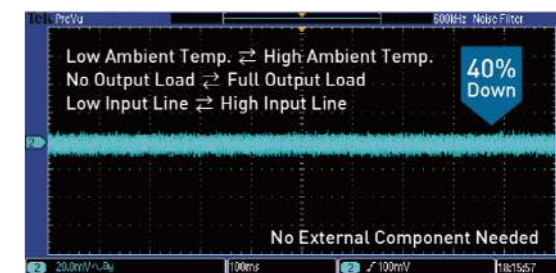

Protection Functions on Abnormal Operation

- MINMAX medical safety power solutions are the instantaneous protection for UVP, OCP, OVP & SCP which help to ensure long-term safety of system operation.

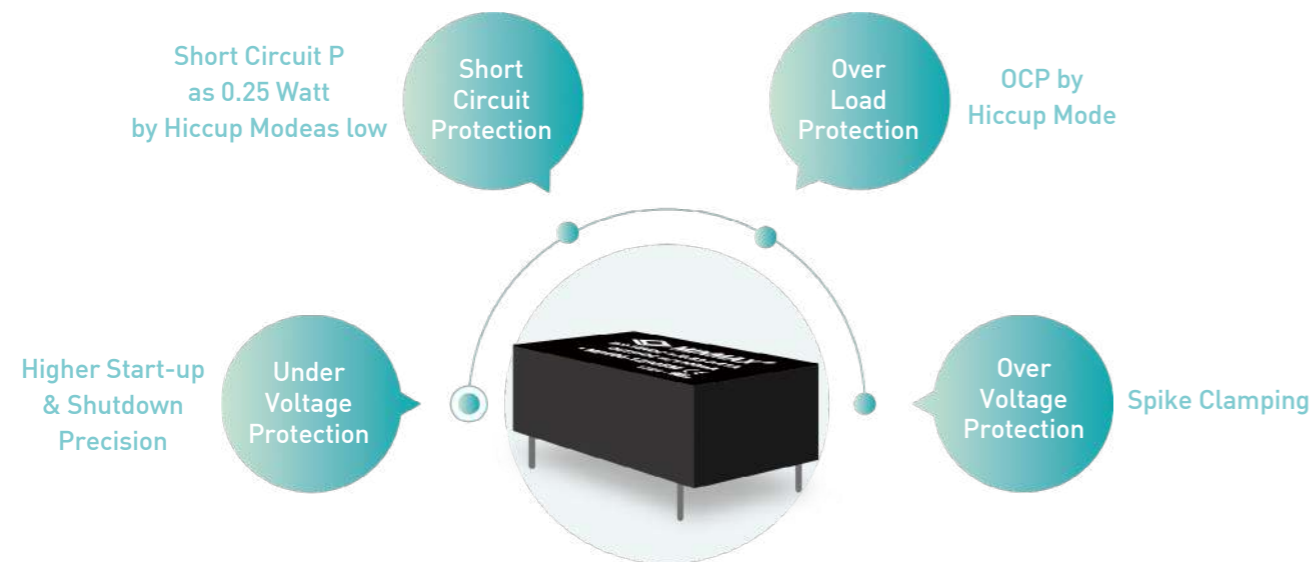

*Example : MIW06-24S12M

Certifications

- ✓ UL/cUL/IEC/EN 62368-1(60950-1) Approved
- ✓ UL 508 Approved
- ✓ Medical Safety IEC/EN 60601-1 & ANSI/AAMI ES 60601-1 Approved
- ✓ CE Marking
- ✓ Protection Class



MINMAX MEDICAL SAFETY POWER SOLUTIONS

SUCCESSFUL APPLICATIONS

- Dental Equipment



- Medical Panel PC



- ECG, EEG
- Medical Assist System
- CPAP Machine

- Mobile Cart Computer



- CT Scanning



- Healthcare Information System



MEDICAL SAFETY PRODUCTS OVERVIEW

Medical Safety DC-DC Converters

Series	Output Power	Input Voltage Range (VDC)	Output Voltage (VDC)	Isolation (VDC)	Efficiency	Operating Ambient Temp. Range ⁽¹⁾	Output Regulation	No Min. Load	OCP	OVP	SCP	Protection Level	ANSI/AAMI ES 60601-1	IEC/EN 60601-1 3 rd
1W • SIP Package														
MAU400	1W	4.5-5.5, 10.8-13.2	5, 12, 15, ±12, ±15	3000VAC Reinforced	75%	-25~+85°C						1xMOPP 2xMOOP	•	•
MAU01M	1W	4.5-5.5, 10.8-13.2, 21.6-26.4	5, 12, 15	4000VAC Reinforced	81%	-40~+95°C					•	2xMOPP	•	•
1-2W • SMD Package														
MSCU01M	1W	4.5-5.5, 10.8-13.2, 21.6-26.4	5, 12, 15, ±12, ±15	4000VAC Reinforced	84%	-40~+95°C					•	2xMOPP	•	•
MSHU100	2W	4.5-5.5, 10.8-13.2, 21.6-26.4	5, 12, 15, ±12, ±15	4000VAC Reinforced	75%	-25~+80°C						1xMOPP 2xMOOP	•	•
2-10W • DIP Package														
MDHU100	2W	4.5-5.5, 10.8-13.2, 21.6-26.4	5, 12, 15, ±12, ±15	4000VAC Reinforced	75%	-25~+80°C						1xMOPP 2xMOOP	•	•
MIHW2000	3W	9-40, 18-80, 36-160	5, 12, ±12, ±15	4000VAC Reinforced	83%	-40~+85°C	•	•	•	•	•	1xMOPP 2xMOOP	•	•
MIW03M	3.5W	4.5-9, 9-18, 18-36, 36-75	5, 5.8, 12, 15, ±12, ±15	5000VAC Reinforced	87%	-40~+96°C	•	•	•	•	•	2xMOPP	•	•
MIW06M	6W	9-18, 18-36, 36-75	5, 12, 15, ±12, ±15	5000VAC Reinforced	89%	-40~+95°C	•	•	•	•	•	2xMOPP	•	•
MIW10M	10W	9-18, 18-36, 36-75	3.3, 5, 5.1, 12, 15, 24, ±12, ±15	5000VAC Reinforced	88%	-40~+90°C	•	•	•	•	•	2xMOPP	•	•
10-20W • 2"x1" Package														
MKW15M	15W	9-18, 18-36, 36-75	5, 5.1, 12, 15, 24, ±12, ±15	4200VAC Reinforced	90%	-40~+85°C	•	•	•	•	•	2xMOPP	•	•
MKW20M	20W	9-18, 18-36, 36-75	5, 5.1, 12, 15, 24, ±12, ±15	4200VAC Reinforced	90%	-40~+80°C	•	•	•	•	•	2xMOPP	•	•

Medical Safety AC-DC Converters

Series	Output Power	Input Voltage Range (VAC)	Output Voltage (VDC)	Isolation (VDC)	Efficiency	Operating Ambient Temp. Range ⁽¹⁾	Output Regulation	No Min. Load	Package	OCP	OVP	Protection Level	ANSI/AAMI ES 60601-1	IEC/EN 60601-1 3 rd
AJM-24	24W	85-264	5,9,12,15, 24,±12 ±15	4000VAC Reinforced	85%	-40~+80°C	•	•	PCB Chassis DIN-Rail	•	•	2xMOPP	•	•
APM-40	40W	85-264	5,12,15, ±12±15	4000VAC Reinforced	85%	-40~+80°C	•	•	PCB Chassis DIN-Rail	•	•	2xMOPP	•	•
AYM-60	60W	85-264	5.1,12, 15,24,48	4000VAC Reinforced	85%	-40~+80°C	•	•	PCB Chassis DIN-Rail	•	•	2xMOPP	•	•

⁽¹⁾Please refer to derating curve information from datasheet

MEDICAL SAFETY • DC-DC CONVERTERS

1W MAU400 Series SIP Package



Model Selection Guide				
Model Number	Input Voltage (VDC)	Output Voltage (VDC)	Output Current (mA)max	Efficiency
MAU401	4.5 - 5.5	5	200	66%
MAU402		12	80	66%
MAU403		15	65±	66%
MAU404		±5	100	66%
MAU405		±12	±40	72%
MAU406		±15	±35	73%
MAU411	10.8 - 13.2	5	200	66%
MAU412		12	80	66%
MAU413		15	65	66%
MAU414		±5	±100	66%
MAU415		±12	±40	74%
MAU416		±15	±35	75%

1W MAU01M Series SIP Package



Model Selection Guide				
Model Number	Input Voltage (VDC)	Output Voltage (VDC)	Output Current (mA)max	Efficiency
MAU01-05S05M	4.5 - 5.5	5	200	79%
MAU01-05S12M		12	84	80%
MAU01-05S15M		15	68	81%
MAU01-12S05M	10.8 - 13.2	5	200	79%
MAU01-12S12M		12	84	81%
MAU01-12S15M		15	68	79%
MAU01-24S05M	21.6 - 26.4	5	200	76%
MAU01-24S12M		12	84	79%
MAU01-24S15M		15	68	79%

*There are different features & spec. by each series. For detailed series datasheet, please refer to www.minmaxpower.com

MEDICAL SAFETY • DC-DC CONVERTERS

1W MSCU01M Series SMD Package



Model Selection Guide

Model Number	Input Voltage (VDC)	Output Voltage (VDC)	Output Current (mA)max	Efficiency
MSCU01-05S05M	4.5 - 5.5	5	200	76%
MSCU01-05S12M		12	84	80%
MSCU01-05S15M		15	68	83%
MSCU01-05D12M		±12	±42	80%
MSCU01-05D15M		±15	±33	84%
MSCU01-12S05M	10.8 - 13.2	5	200	76%
MSCU01-12S12M		12	84	79%
MSCU01-12S15M		15	68	80%
MSCU01-12D12M		±12	±42	79%
MSCU01-12D15M		±15	±33	80%
MSCU01-24S05M	21.6 - 26.4	5	200	76%
MSCU01-24S12M		12	84	80%
MSCU01-24S15M		15	68	80%
MSCU01-24D12M		±12	±42	80%
MSCU01-24D15M		±15	±33	80%

2W MSHU100 Series SMD Package



Model Selection Guide

Model Number	Input Voltage (VDC)	Output Voltage (VDC)	Output Current (mA)max	Efficiency
MSHU102	4.5 - 5.5	5	400	66%
MSHU104		12	165	66%
MSHU105		15	133	66%
MSHU108		±12	±83	72%
MSHU109		±15	±66	73%
MSHU112	10.8 - 13.2	5	400	66%
MSHU114		12	165	66%
MSHU115		15	133	66%
MSHU118		±12	±83	74%
MSHU119		±15	±66	75%
MSHU122	21.6 - 26.4	5	400	66%
MSHU124		12	165	66%
MSHU125		15	133	66%
MSHU128		±12	±83	74%
MSHU129		±15	±66	75%

*There are different features & spec. by each series. For detailed series datasheet, please refer to www.minmaxpower.com

MEDICAL SAFETY • DC-DC CONVERTERS

2W MDHU100 Series DIP Package



Model Selection Guide

Model Number	Input Voltage (VDC)	Output Voltage (VDC)	Output Current (mA)max	Efficiency
MDHU102	4.5 - 5.5	5	400	66%
MDHU104		12	165	66%
MDHU105		15	133	66%
MDHU108		±12	±83	72%
MDHU109		±15	±66	73%
MDHU112	10.8 - 13.2	5	400	66%
MDHU114		12	165	66%
MDHU115		15	133	66%
MDHU118		±12	±83	74%
MDHU119		±15	±66	75%
MDHU122	21.6 - 26.4	5	400	66%
MDHU124		12	165	66%
MDHU125		15	133	66%
MDHU128		±12	±83	74%
MDHU129		±15	±66	75%

3W MIHW2000 Series DIP Package



Model Selection Guide

Model Number	Input Voltage (VDC)	Output Voltage (VDC)	Output Current (mA)max	Efficiency
MIHW2022	9 - 40	5	600	78%
MIHW2023		12	250	83%
MIHW2026		±12	±125	83%
MIHW2027		±15	±100	83%
MIHW2032		5	600	78%
MIHW2033	18 - 80	12	250	83%
MIHW2036		±12	±125	83%
MIHW2037		±15	±100	83%
MIHW2042	36 - 160	5	600	78%
MIHW2043		12	250	83%
MIHW2046		±12	±125	83%
MIHW2047		±15	±100	83%

*There are different features & spec. by each series. For detailed series datasheet, please refer to www.minmaxpower.com

MEDICAL SAFETY • DC-DC CONVERTERS

3.5W MIW03M Series DIP Package



Model Selection Guide				
Model Number	Input Voltage (VDC)	Output Voltage (VDC)	Output Current (mA)max	Efficiency
MIW03-05S05M	4.5 - 9	5	700	83%
MIW03-05S058M		5.8	600	83%
MIW03-05S12M		12	290	84%
MIW03-05S15M		15	235	84%
MIW03-05D12M		±12	±145	84%
MIW03-05D15M		±15	±115	84%
MIW03-12S05M	9 - 18	5	700	83%
MIW03-12S12M		12	290	87%
MIW03-12S15M		15	235	87%
MIW03-12D12M		±12	±145	87%
MIW03-12D15M		±15	±115	87%
MIW03-24S05M		18 - 36	5	700
MIW03-24S12M	12		290	86%
MIW03-24S15M	15		235	87%
MIW03-24D12M	±12		±145	87%
MIW03-24D15M	±15		±115	86%
MIW03-48S05M	36 - 75		5	700
MIW03-48S12M		12	290	86%
MIW03-48S15M		15	235	85%
MIW03-48D12M		±12	±145	84%
MIW03-48D15M		±15	±115	84%

6W MIW06M Series DIP Package



Model Selection Guide				
Model Number	Input Voltage (VDC)	Output Voltage (VDC)	Output Current (mA)max	Efficiency
MIW06-12S05M	9 - 18	5	1200	84%
MIW06-12S12M		12	500	87%
MIW06-12S15M		15	400	86%
MIW06-12D12M		±12	±250	87%
MIW06-12D15M		±15	±200	87%
MIW06-24S05M		18 - 36	5	1200
MIW06-24S12M	12		500	87%
MIW06-24S15M	15		400	87%
MIW06-24D12M	±12		±250	86%
MIW06-24D15M	±15		±200	87%
MIW06-48S05M	36 - 75		5	1200
MIW06-48S12M		12	500	87%
MIW06-48S15M		15	400	89%
MIW06-48D12M		±12	±250	87%
MIW06-48D15M		±15	±200	88%

*There are different features & spec. by each series.
For detailed series datasheet, please refer to www.minmaxpower.com

MEDICAL SAFETY • DC-DC CONVERTERS

10W MIW10M Series DIP Package



Model Selection Guide					
Model Number	Input Voltage (VDC)	Output Voltage (VDC)	Output Current (mA)max	Efficiency	
MIW10-12S033M	9 - 18	3.3	2700	81%	
MIW10-12S05M		5	2000	84%	
MIW10-12S051M		5.1	2000	84%	
MIW10-12S12M		12	833	87%	
MIW10-12S15M		15	666	88%	
MIW10-12S24M		24	416	88%	
MIW10-12D12M		±12	±416	88%	
MIW10-12D15M		±15	±333	87%	
MIW10-24S033M		18 - 36	3.3	2700	81%
MIW10-24S05M			5	2000	85%
MIW10-24S051M			5.1	2000	85%
MIW10-24S12M			12	833	88%
MIW10-24S15M	15		666	88%	
MIW10-24S24M	24		416	88%	
MIW10-24D12M	±12		±416	88%	
MIW10-24D15M	±15		±333	87%	
MIW10-48S033M	36 - 75		3.3	2700	81%
MIW10-48S05M			5	2000	85%
MIW10-48S051M			5.1	2000	85%
MIW10-48S12M			12	833	88%
MIW10-48S15M		15	666	88%	
MIW10-48S24M		24	416	87%	
MIW10-48D12M		±12	±416	87%	
MIW10-48D15M		±15	±333	87%	

15W MKW15M Series 2"x1" Package



Model Selection Guide				
Model Number	Input Voltage (VDC)	Output Voltage (VDC)	Output Current (mA)max	Efficiency
MKW15-12S05M	9 - 18	5	3000	86%
MKW15-12S051M		5.1	3000	86%
MKW15-12S12M		12	1250	89%
MKW15-12S12M		15	1000	88%
MKW15-12S24M		24	625	88%
MKW15-12D12M		±12	±625	88%
MKW15-12D15M	±15	±500	89%	
MKW15-24S05M	18 - 36	5	3000	88%
MKW15-24S051M		5.1	3000	88%
MKW15-24S12M		12	1250	89%
MKW15-24S15M		15	1000	89%
MKW15-24S24M		24	625	90%
MKW15-24D12M		±12	±625	90%
MKW15-24D15M	±15	±500	89%	
MKW15-48S05M	36 - 75	5	3000	88%
MKW15-48S051M		5.1	3000	88%
MKW15-48S12M		12	1250	88%
MKW15-48S15M		15	1000	90%
MKW15-48S24M		24	625	89%
MKW15-48D12M		±12	±625	89%
MKW15-48D15M	±15	±500	88%	

*There are different features & spec. by each series.
For detailed series datasheet, please refer to www.minmaxpower.com

MEDICAL SAFETY • DC-DC CONVERTERS

20W MKW20M Series 2"x1" Package



Model Selection Guide				
Model Number	Input Voltage (VDC)	Output Voltage (VDC)	Output Current (mA)max	Efficiency
MKW20-12S05M	9 - 18	5	4000	86%
MKW20-12S051M		5.1	4000	86%
MKW20-12S12M		12	1670	89%
MKW20-12S15M		15	1333	88%
MKW20-12S24M		24	840	89%
MKW20-12D12M		±12	±840	89%
MKW20-12D15M		±15	±670	89%
MKW20-24S05M	18 - 36	5	4000	88%
MKW20-24S051M		5.1	4000	88%
MKW20-24S12M		12	1670	89%
MKW20-24S15M		15	1333	89%
MKW20-24S24M		24	840	90%
MKW20-24D12M		±12	±840	90%
MKW20-24D15M		±15	±670	90%
MKW20-48S05M	36 - 75	5	4000	88%
MKW20-48S051M		5.1	4000	88%
MKW20-48S12M		12	1670	89%
MKW20-48S15M		15	1333	90%
MKW20-48S24M		24	840	89%
MKW20-48D12M		±12	±840	89%
MKW20-48D15M		±15	±670	90%

*There are different features & spec. by each series. For detailed series datasheet, please refer to www.minmaxpower.com

MEDICAL SAFETY • AC-DC POWER SUPPLIES

24W AJM-24 Series Encapsulated Package



Model Selection Guide				
Model Number	Input Voltage (VAC)	Output Voltage (VDC)	Output Current (mA)max	Efficiency
AJM-24S05	85 - 264	5	3000	77%
AJM-24S09		9	2666	82%
AJM-24S12		12	2000	83%
AJM-24S15		15	1600	82%
AJM-24S24		24	1000	85%
AJM-24D12		±12	±1000	84%
AJM-24D15		±15	±800	84%

40W APM-40 Series Encapsulated Package



Model Selection Guide				
Model Number	Input Voltage (VAC)	Output Voltage (VDC)	Output Current (mA)max	Efficiency
APM-40S05	85 - 264	5	8000	81%
APM-40S12		12	3330	84%
APM-40S15		15	2660	85%
APM-40S24		24	1660	84%
APM-40D12		±12	±1660	84%
APM-40D15		±15	±1330	85%

60W AYM-60 Series Encapsulated Package



Model Selection Guide				
Model Number	Input Voltage (VAC)	Output Voltage (VDC)	Output Current (mA)max	Efficiency
AYM-60S051	85 - 264	5.1	10000	84%
AYM-60S12		12	5000	87%
AYM-60S15		15	4000	87%
AYM-60S24		24	2500	87%
AYM-60S48		48	1250	88%

*There are different features & spec. by each series. For detailed series datasheet, please refer to www.minmaxpower.com

MINMAX POWER SOLUTIONS DC-DC CONVERTERS · AC-DC POWER SUPPLIES | 1-150W



GENERAL INDUSTRIAL

• DC-DC CONVERTERS

<p>SIP Package</p>  <p>1-5W</p>	<p>SMD Package</p>  <p>1-6W</p>	<p>DIP Package</p>  <p>1-15W</p>
<p>1"×1" Package</p>  <p>10-30W</p>	<p>2"×1" Package</p>  <p>40-50W</p>	<p>Chassis & DIN-Rail Mounting</p>  <p>6-60W</p>

• AC-DC POWER SUPPLIES

<p>Encapsulated Package</p>  <p>3-60W</p>
--

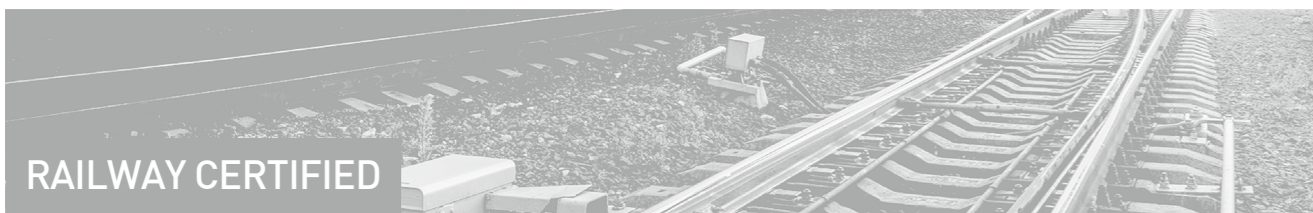

RAILWAY CERTIFIED

• DC-DC CONVERTERS

<p>DIP Package</p>  <p>3W</p>	<p>2"×1" Package</p>  <p>10-40W</p>	<p>Quarter Brick</p>  <p>50-150W</p>
--	--	---

MINMAX POWER SOLUTIONS DC-DC CONVERTERS · AC-DC POWER SUPPLIES | 1-150W

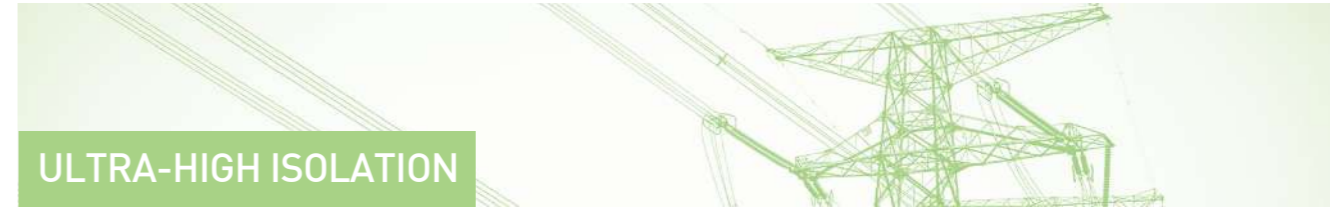

ULTRA-HIGH ISOLATION





• DC-DC CONVERTERS

<p>SIP Package</p>  <p>1-2W</p>	<p>SMD Package</p>  <p>1W</p>	<p>DIP Package</p>  <p>2-10W</p>
<p>2"×1" Package</p>  <p>15-20W</p>	<p>Chassis & DIN-Rail Mounting</p>  <p>6-60W</p>	



MEDICAL SAFETY

• DC-DC CONVERTERS

<p>SIP Package</p>  <p>1W</p>	<p>SMD Package</p>  <p>1-2W</p>
<p>DIP Package</p>  <p>2-10W</p>	<p>2"×1" Package</p>  <p>15-20W</p>

• AC-DC POWER SUPPLIES

<p>Encapsulated Package</p>  <p>24-60W</p>

**POWER FOR
A BETTER FUTURE**

FOR MORE INFO, PLEASE GO TO  www.minimaxpower.com



ADDRESS

No.77,Sec.1,Zhonghua W.Rd.,
South Dist.,Tainan City 702,Taiwan

MAIL

sales@minmax.com.tw

TELEPHONE

(+886) 6-2923150

FAX

(+886) 6-2923149

