



**MINMAX<sup>®</sup>**

**MJW15 Series**

**Electric Characteristic Note**

# MJW15 Series EC Note

DC-DC CONVERTER 15W, Regulated Output, 1"x1" Package

## Features

- ▶ Industrial Standard 1" x 1" Package
- ▶ Wide 2:1 Input Voltage Range
- ▶ Fully Regulated Output Voltage
- ▶ I/O Isolation 1500VDC
- ▶ Operating Ambient Temp. Range -40°C to +90°C
- ▶ Low No Load Power Consumption
- ▶ No Min. Load Requirement
- ▶ Under-voltage, Overload/Voltage and Short Circuit Protection
- ▶ Remote On/Off Control, Output Voltage Trim
- ▶ Shielded Metal Case with Insulated Baseplate
- ▶ Conducted EMI EN 55032 Class A Approved
- ▶ UL/cUL/IEC/EN 62368-1(60950-1) Safety Approval & CE Marking

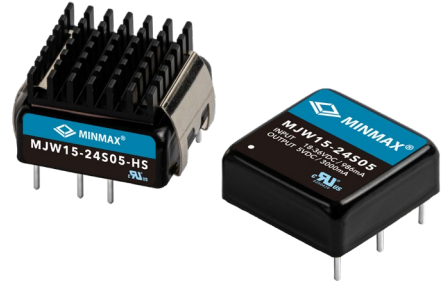

## Applications

- ▶ Distributed power architectures
- ▶ Workstations
- ▶ Computer equipment
- ▶ Communications equipment

## Product Overview

The MINMAX MJW15 series is a range of cost-optimized 15W isolated DC-DC converter within an encapsulated 1"x1" industrial standard package. There are 21 models available for 12, 24, 48VDC with wide 2:1 input voltage range and fixed output voltage regulation. The MJW15 series come in a shielded metal package and conducted EMI EN 55032 Class A approved without external components. By state-of-the-art circuit topology and 91% high efficiency could be achieved allowing an operating temperature of -40°C to +90°C as well as low standby power consumption. Further features include remote ON/OFF, trimmable output voltage, under-voltage protection, overload protection, over voltage protection, short circuit protection and no min. load requirement as well. These DC-DC converters offer a better solution for critical space applications to reduce PCB layout demand area like battery-powered equipment, instrumentation, distributed power architectures in communication, industrial electronics, energy facilities and others.

## Table of contents

Model Selection Guide .....	P2	External Output Trimming.....	P27
Input Specifications.....	P2	Test Setup.....	P28
Remote On/Off Control .....	P2	Technical Notes .....	P28
Output Specifications.....	P3	Remote On/Off Implementation.....	P29
General Specifications.....	P3	Packaging Information for Tube .....	P29
EMC Specifications.....	P3	Wave Soldering Considerations .....	P30
Environmental Specifications .....	P4	Hand Welding Parameter .....	P30
Characteristic Curves .....	P5	Part Number Structure .....	P31
Package Specifications .....	P26	MTBF and Reliability .....	P31
Recommended Pad Layout for Single & Dual Output Converter.....	P27		

**Model Selection Guide**

Model Number	Input Voltage (Range)	Output Voltage	Output Current	Input Current		Reflected Ripple Current	Over Voltage Protection	Max. capacitive Load	Efficiency (typ.)
				Max.	@No Load				@Max. Load
	VDC	VDC	mA	mA(typ.)	mA(typ.)	mA (typ.)	VDC	μF	%
MJW15-12S033	12 (9 ~ 18)	3.3	3400	1087	10	80	3.9	5800	86
MJW15-12S05		5	3000	1404	10		6.2	5100	89
MJW15-12S12		12	1250	1404	10		15	870	89
MJW15-12S15		15	1000	1404	10		18	560	89
MJW15-12S24		24	625	1389	10		30	220	90
MJW15-12D12		±12	±625	1404	15		±15	440#	89
MJW15-12D15		±15	±500	1389	15		±18	280#	90
MJW15-24S033	24 (18 ~ 36)	3.3	3400	544	8	50	3.9	5800	86
MJW15-24S05		5	3000	710	8		6.2	5100	88
MJW15-24S12		12	1250	694	8		15	870	90
MJW15-24S15		15	1000	694	8		18	560	90
MJW15-24S24		24	625	687	8		30	220	91
MJW15-24D12		±12	±625	694	10		±15	440#	90
MJW15-24D15		±15	±500	694	10		±18	280#	90
MJW15-48S033	48 (36 ~ 75)	3.3	3400	269	8	30	3.9	5800	87
MJW15-48S05		5	3000	355	8		6.2	5100	88
MJW15-48S12		12	1250	347	8		15	870	90
MJW15-48S15		15	1000	347	8		18	560	90
MJW15-48S24		24	625	343	8		30	220	91
MJW15-48D12		±12	±625	351	10		±15	440#	89
MJW15-48D15		±15	±500	347	10		±18	280#	90

# For each output

**Input Specifications**

Parameter	Conditions / Model	Min.	Typ.	Max.	Unit
Input Surge Voltage (100 ms max.)	12V Input Models	-0.7	---	25	VDC
	24V Input Models	-0.7	---	50	
	48V Input Models	-0.7	---	100	
Start-Up Threshold Voltage	12V Input Models	---	---	9	
	24V Input Models	---	---	18	
	48V Input Models	---	---	36	
Under Voltage Shutdown	12V Input Models	---	7.5	---	
	24V Input Models	---	16	---	
	48V Input Models	---	34	---	
Start Up Time (Power On)	Nominal Vin and Constant Resistive Load	---	---	30	ms
Input Filter	All Models	Internal LC Type			

**Remote On/Off Control**

Parameter	Conditions	Min.	Typ.	Max.	Unit
Converter On	3.5V ~ 12V or Open Circuit				
Converter Off	0V ~ 1.2V or Short Circuit				
Control Input Current (on)	Vctrl = 5.0V	---	---	0.5	mA
Control Input Current (off)	Vctrl = 0V	---	---	-0.5	mA
Control Common	Referenced to Negative Input				
Standby Input Current	Nominal Vin	---	3	---	mA

Output Specifications							
Parameter	Conditions / Model		Min.	Typ.	Max.	Unit	
Output Voltage Setting Accuracy			---	---	±1.0	%Vnom.	
Output Voltage Balance	Dual Output, Balanced Loads		---	---	±2.0	%	
Line Regulation	Vin=Min. to Max. @Full Load	Single Output	---	---	±0.2	%	
		Dual Output	---	---	±0.5	%	
Load Regulation	Io=0% to 100%	Single Output	3.3V & 5V	---	---	±0.5	%
			12V,15V & 24V	---	---	±0.2	%
		Dual Output	---	---	±1.0	%	
Load Cross Regulation (Dual Output)	Asymmetrical Load 25%/100% Full Load		---	---	±5.0	%	
Minimum Load	No minimum Load Requirement						
Ripple & Noise	0-20 MHz Bandwidth	3.3V & 5V Models	---	---	75	mV <sub>p,p</sub>	
		12V, 15V & Dual Output Models	---	---	100	mV <sub>p,p</sub>	
		24V Models	---	---	150	mV <sub>p,p</sub>	
Transient Recovery Time	25% Load Step Change		---	300	---	µsec	
Transient Response Deviation	25% Load Step Change		---	±3	±5	%	
Temperature Coefficient			---	---	±0.02	%/°C	
Trim Up / Down Range	% of nominal output voltage		---	---	±10	%	
Over Load Protection	Hiccup		---	150	---	%	
Short Circuit Protection	Continuous, Automatic Recovery (Hiccup Mode 0.7Hz typ.)						

General Specifications						
Parameter	Conditions		Min.	Typ.	Max.	Unit
I/O Isolation Voltage	60 Seconds		1500	---	---	VDC
	1 Second		1800	---	---	VDC
Isolation Voltage Input/Output to case			1000	---	---	VDC
I/O Isolation Resistance	500 VDC		1000	---	---	MΩ
I/O Isolation Capacitance	100kHz, 1V		---	---	1500	pF
Switching Frequency			---	330	---	kHz
MTBF(calculated)	MIL-HDBK-217F@25°C, Ground Benign		1,489,680	---	---	Hours
Safety Approvals	UL/cUL 60950-1 recognition(UL certificate), IEC/EN 60950-1(CB-report)					
	UL/cUL 62368-1 recognition(UL certificate), IEC/EN 62368-1(CB-report)					

EMC Specifications					
Parameter	Standards & Level			Performance	
EMI <sub>(e)</sub>	Conduction	EN 55032	Without external components		Class A
	Radiation		With external components		
EMS <sub>(e)</sub>	EN 55035				
	ESD	EN 61000-4-2 Air± 8kV , Contact ±6kV			A
	Radiated immunity	EN 61000-4-3 10V/m			A
	Fast transient	EN 61000-4-4 ±2kV			A
	Surge	EN 61000-4-5 ±1kV			A
	Conducted immunity	EN 61000-4-6 10V/rms			A
	PFMF	EN 61000-4-8 100A/m			A

Environmental Specifications					
Parameter	Conditions / Model	Min.	Max.		Unit
			without Heatsink	with Heatsink	
Operating Ambient Temperature Range Nominal Vin, Load 100% Inom. (for Power Derating see relative Derating Curves)	MJW15-24S24, MJW15-48S24	-40	+78	+82	°C
	MJW15-12S24, MJW15-12D15, MJW15-24S12 MJW15-24S15 MJW15-24D12, MJW15-24D15 MJW15-48S12, MJW15-48S15, MJW15-48D15		+75	+80	
	MJW15-48S033		+74	+79	
	MJW15-12S033, MJW15-24S033		+72	+77	
	MJW15-12S05, MJW15-12S12, MJW15-12S15 MJW15-12D12, MJW15-48D12		+71	+77	
	MJW15-24S05, MJW15-48S05		+68	+74	
Thermal Impedance	20LFM Convection without Heatsink	18.2	---	---	°C/W
	20LFM Convection with Heatsink	15.3	---	---	°C/W
	100LFM Convection without Heatsink	13.9	---	---	°C/W
	100LFM Convection with Heatsink	8.8	---	---	°C/W
	200LFM Convection without Heatsink	12.1	---	---	°C/W
	200LFM Convection with Heatsink	6.8	---	---	°C/W
	400LFM Convection without Heatsink	9.1	---	---	°C/W
	400LFM Convection with Heatsink	4.6	---	---	°C/W
Case Temperature		---	+105	---	°C
Storage Temperature Range		-50	+125	---	°C
Humidity (non condensing)		---	95	---	% rel. H
RFI	Six-Sided Shielded, Metal Case				
Lead Temperature (1.5mm from case for 10Sec.)		---	260	---	°C

Notes	
1	Specifications typical at Ta=+25°C, resistive load, nominal input voltage and rated output current unless otherwise noted.
2	Transient recovery time is measured to within 1% error band for a step change in output load of 75% to 100%.
3	Ripple & Noise measured with a 1µF MLCC.
4	We recommend to protect the converter by a slow blow fuse in the input supply line.
5	Other input and output voltage may be available, please contact MINMAX.
6	The external components might be required to meet EMI/EMS standard for some of test items. Please contact MINMAX for the solution in detail.
7	Specifications are subject to change without notice.
8	The repeated high voltage isolation testing of the converter can degrade isolation capability, to a lesser or greater degree depending on materials, construction, environment and reflow solder process. Any material is susceptible to eventual chemical degradation when subject to very high applied voltages thus implying that the number of tests should be strictly limited. We therefore strongly advise against repeated high voltage isolation testing, but if it is absolutely required, that the voltage be reduced by 20% from specified test voltage. Furthermore, the high voltage isolation capability after reflow solder process should be evaluated as it is applied on system.

**Characteristic Curves**

All test conditions are at 25°C The figures are identical for MJW15-12S033

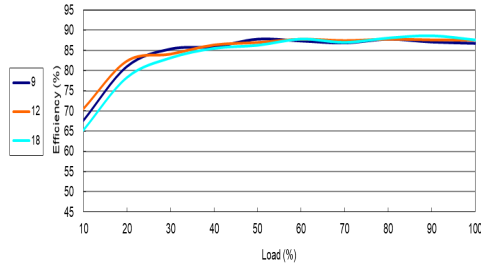

Efficiency Versus Output Current

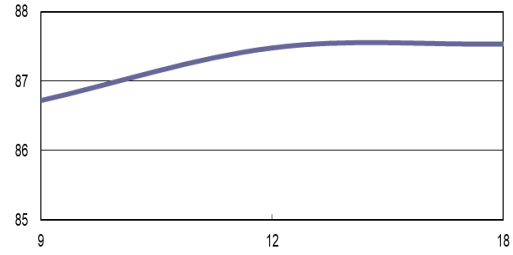

Efficiency Versus Input Voltage Full Load

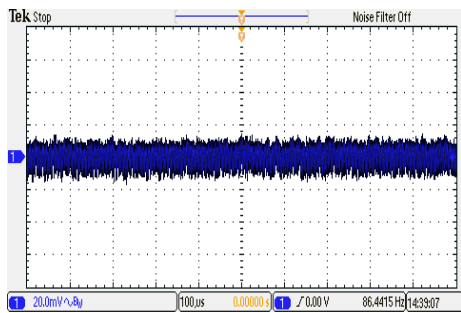

Typical Output Ripple and Noise  
 $V_{in}=V_{in\ nom}$  ; Full Load

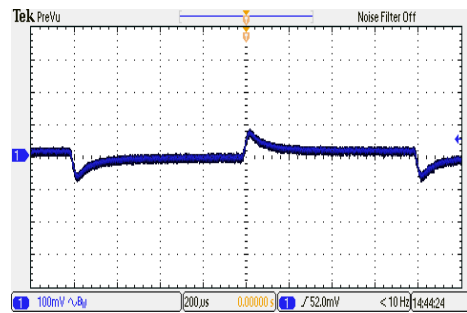

Transient Response to Dynamic Load Change  
from 100% to 75% of Full Load ;  $V_{in}=V_{in\ nom}$

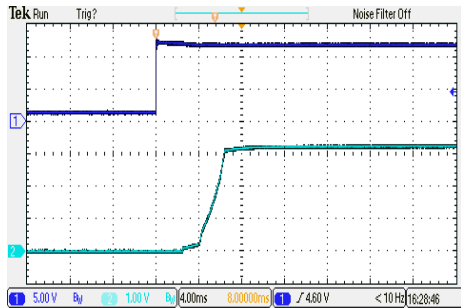

Typical Input Start-Up and Output Rise Characteristic  
 $V_{in}=V_{in\ nom}$  ; Full Load

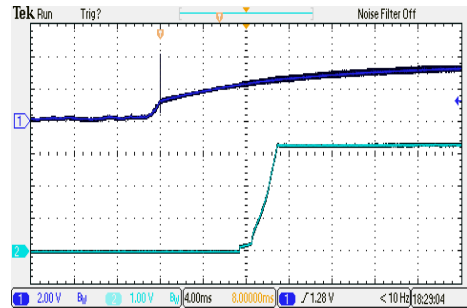

ON/OFF Voltage Start-Up and Output Rise Characteristic  
 $V_{in}=V_{in\ nom}$  ; Full Load

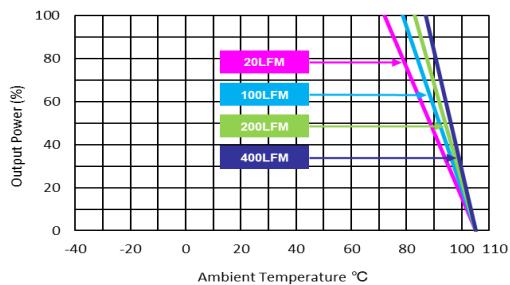

Derating Output Power Versus Ambient Temperature and Airflow  
 $V_{in}=V_{in\ nom}$



**Characteristic Curves**

All test conditions are at 25°C The figures are identical for MJW15-12S05

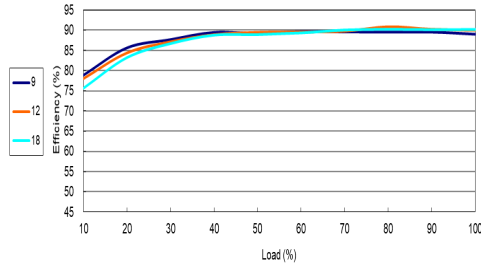

Efficiency Versus Output Current

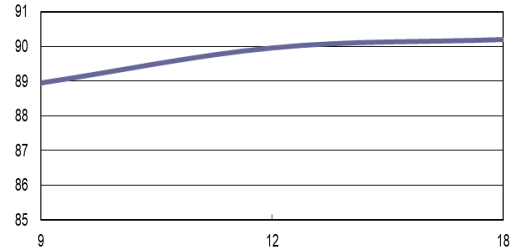

Efficiency Versus Input Voltage Full Load

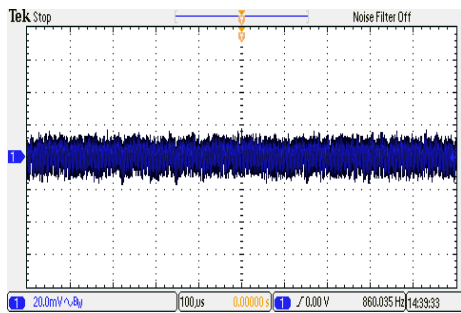

Typical Output Ripple and Noise  
 $V_{in}=V_{in\ nom}$  ; Full Load

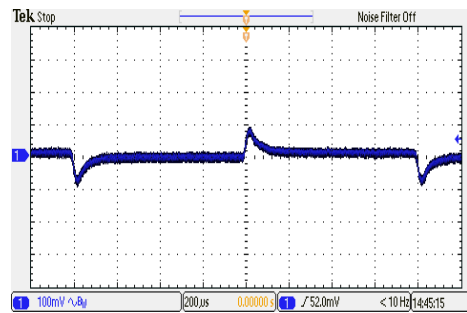

Transient Response to Dynamic Load Change  
from 100% to 75% of Full Load ;  $V_{in}=V_{in\ nom}$

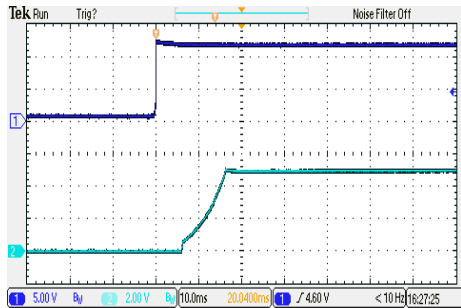

Typical Input Start-Up and Output Rise Characteristic  
 $V_{in}=V_{in\ nom}$  ; Full Load

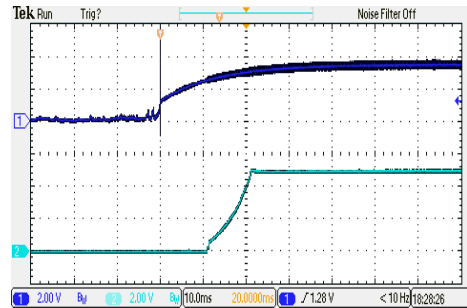

ON/OFF Voltage Start-Up and Output Rise Characteristic  
 $V_{in}=V_{in\ nom}$  ; Full Load

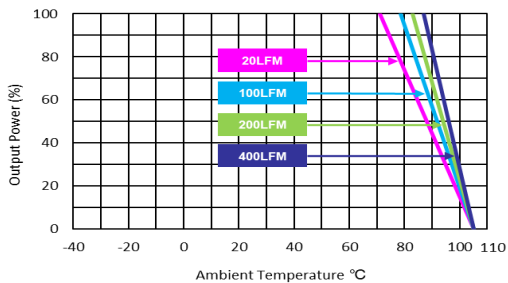

Derating Output Power Versus Ambient Temperature and Airflow  
 $V_{in}=V_{in\ nom}$

**Characteristic Curves**

All test conditions are at 25°C The figures are identical for MJW15-12S12

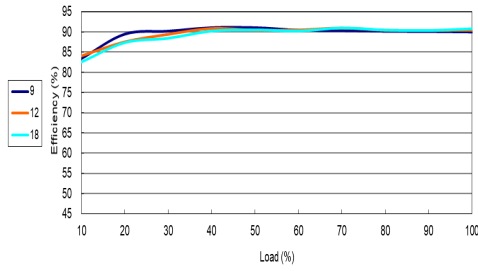

Efficiency Versus Output Current

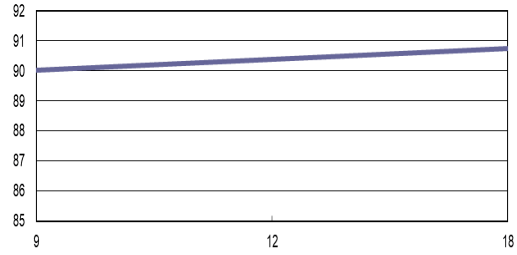

Efficiency Versus Input Voltage Full Load

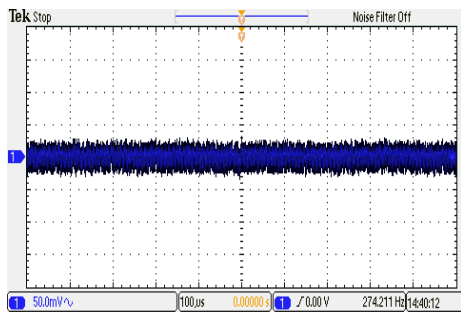

Typical Output Ripple and Noise  
 $V_{in}=V_{in\ nom}$  ; Full Load

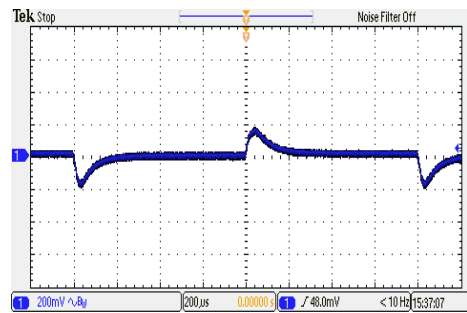

Transient Response to Dynamic Load Change  
from 100% to 75% of Full Load ;  $V_{in}=V_{in\ nom}$

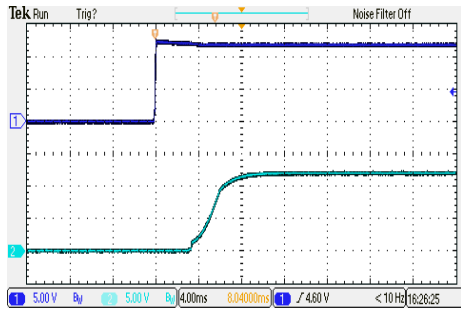

Typical Input Start-Up and Output Rise Characteristic  
 $V_{in}=V_{in\ nom}$  ; Full Load

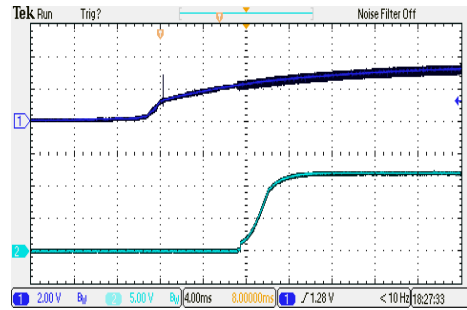

ON/OFF Voltage Start-Up and Output Rise Characteristic  
 $V_{in}=V_{in\ nom}$  ; Full Load

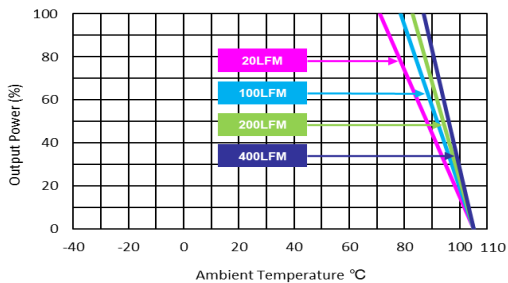

Derating Output Power Versus Ambient Temperature and Airflow  
 $V_{in}=V_{in\ nom}$



**Characteristic Curves**

All test conditions are at 25°C The figures are identical for MJW15-12S15

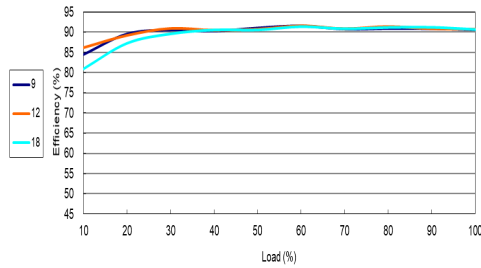

Efficiency Versus Output Current

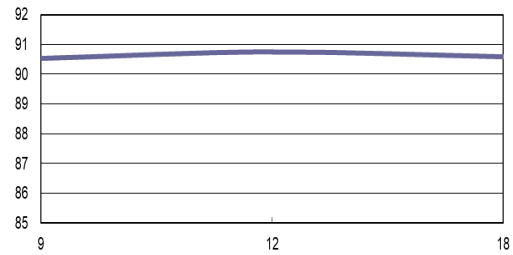

Efficiency Versus Input Voltage Full Load

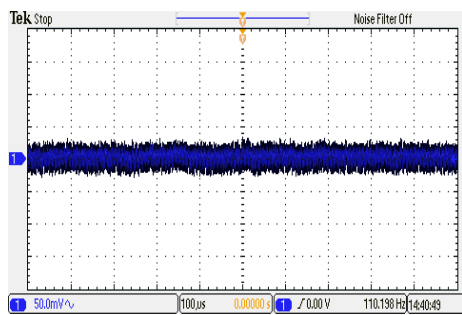

Typical Output Ripple and Noise  
 $V_{in}=V_{in\ nom}$  ; Full Load

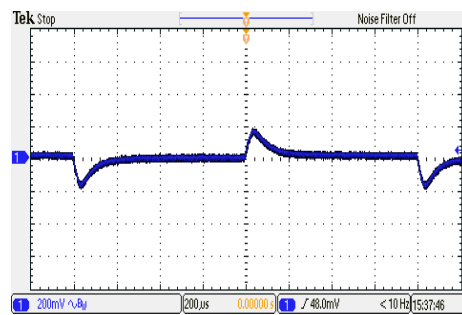

Transient Response to Dynamic Load Change  
from 100% to 75% of Full Load ;  $V_{in}=V_{in\ nom}$

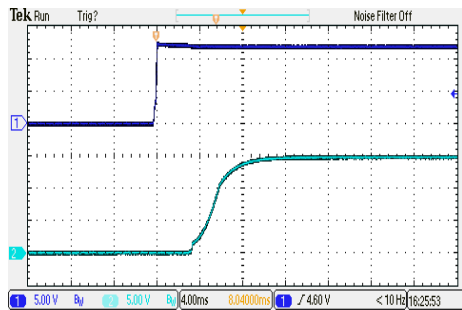

Typical Input Start-Up and Output Rise Characteristic  
 $V_{in}=V_{in\ nom}$  ; Full Load

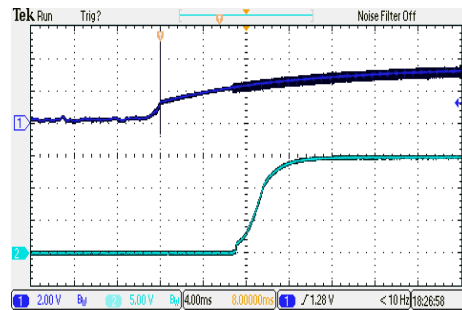

ON/OFF Voltage Start-Up and Output Rise Characteristic  
 $V_{in}=V_{in\ nom}$  ; Full Load

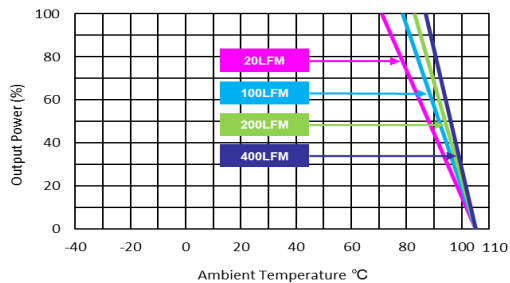

Derating Output Power Versus Ambient Temperature and Airflow  
 $V_{in}=V_{in\ nom}$

**Characteristic Curves**

All test conditions are at 25°C The figures are identical for MJW15-12S24

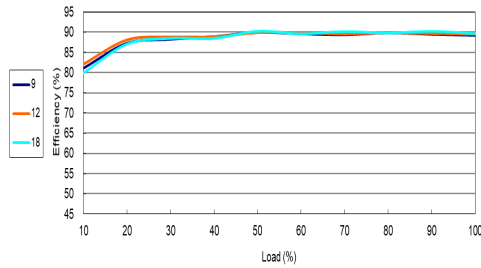

Efficiency Versus Output Current

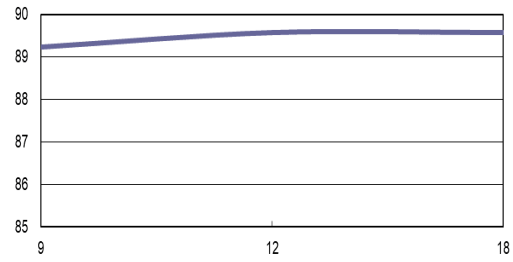

Efficiency Versus Input Voltage Full Load

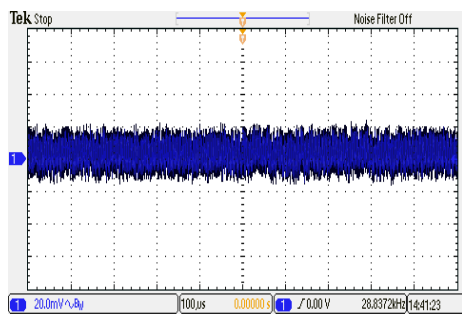

Typical Output Ripple and Noise  
 $V_{in}=V_{in\ nom}$  ; Full Load

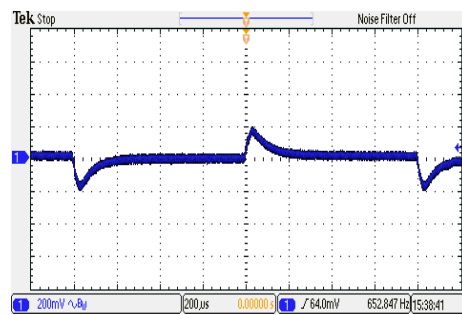

Transient Response to Dynamic Load Change  
from 100% to 75% of Full Load ;  $V_{in}=V_{in\ nom}$

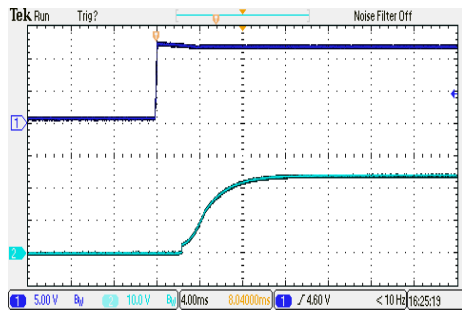

Typical Input Start-Up and Output Rise Characteristic  
 $V_{in}=V_{in\ nom}$  ; Full Load

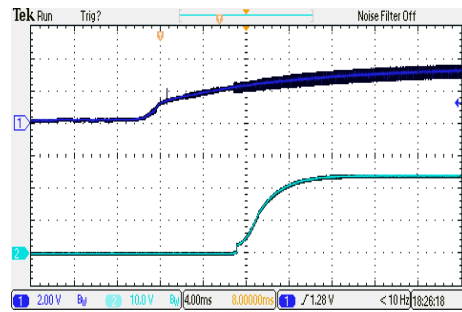

ON/OFF Voltage Start-Up and Output Rise Characteristic  
 $V_{in}=V_{in\ nom}$  ; Full Load

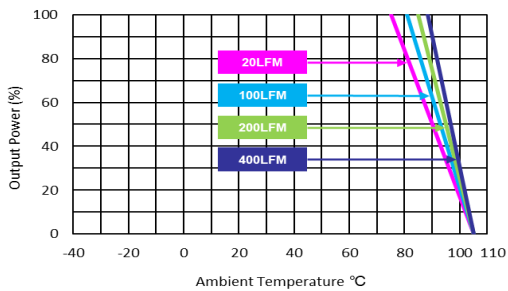

Derating Output Power Versus Ambient Temperature and Airflow  
 $V_{in}=V_{in\ nom}$

**Characteristic Curves**

All test conditions are at 25°C. The figures are identical for MJW15-12D12.

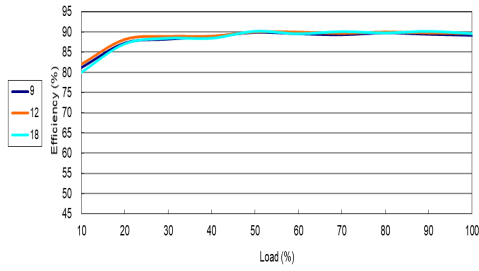

Efficiency Versus Output Current

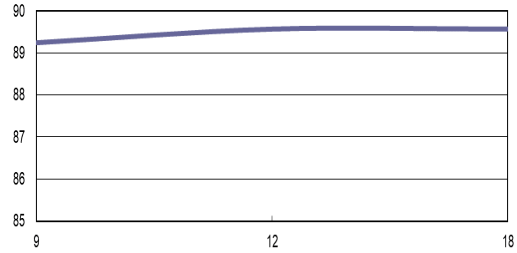

Efficiency Versus Input Voltage Full Load

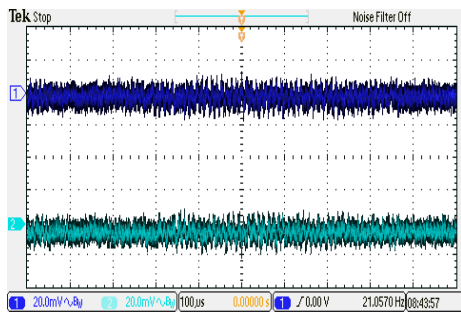

Typical Output Ripple and Noise  
 $V_{in}=V_{in\ nom}$  ; Full Load

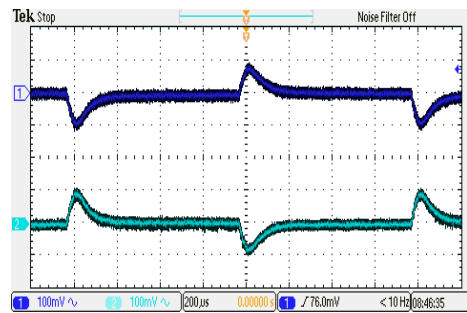

Transient Response to Dynamic Load Change  
from 100% to 75% of Full Load ;  $V_{in}=V_{in\ nom}$

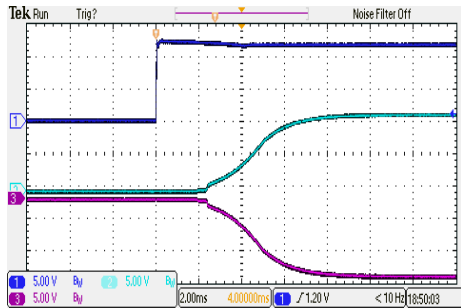

Typical Input Start-Up and Output Rise Characteristic  
 $V_{in}=V_{in\ nom}$  ; Full Load

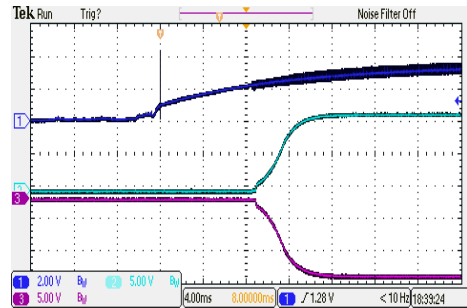

ON/OFF Voltage Start-Up and Output Rise Characteristic  
 $V_{in}=V_{in\ nom}$  ; Full Load

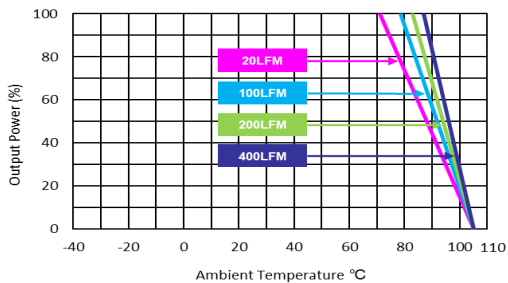

Derating Output Power Versus Ambient Temperature and Airflow  
 $V_{in}=V_{in\ nom}$

**Characteristic Curves**

All test conditions are at 25°C The figures are identical for MJW15-12D15

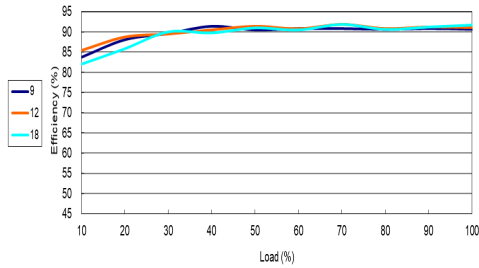

Efficiency Versus Output Current

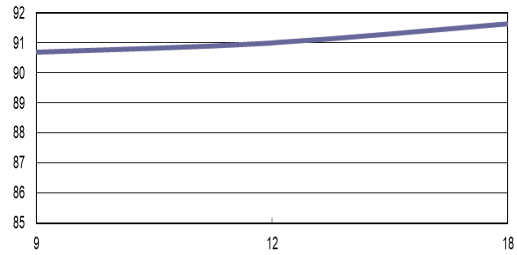

Efficiency Versus Input Voltage Full Load

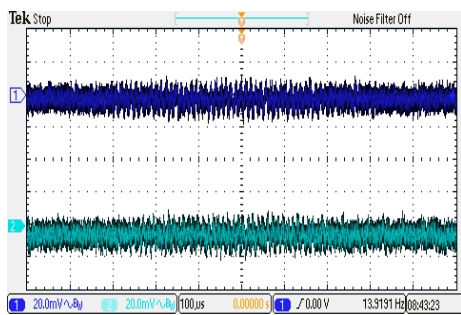

Typical Output Ripple and Noise  
 $V_{in}=V_{in\ nom}$  ; Full Load

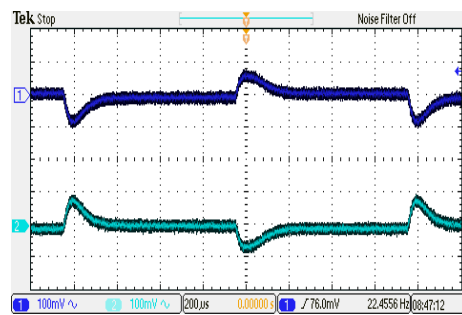

Transient Response to Dynamic Load Change  
from 100% to 75% of Full Load ;  $V_{in}=V_{in\ nom}$

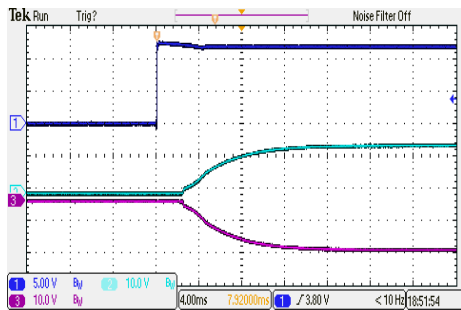

Typical Input Start-Up and Output Rise Characteristic  
 $V_{in}=V_{in\ nom}$  ; Full Load

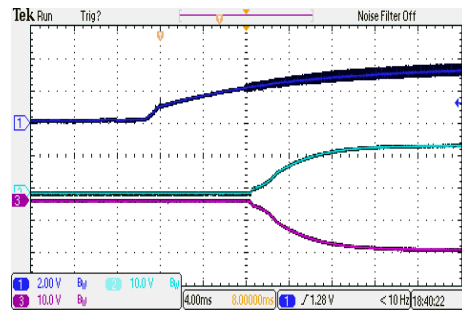

ON/OFF Voltage Start-Up and Output Rise Characteristic  
 $V_{in}=V_{in\ nom}$  ; Full Load

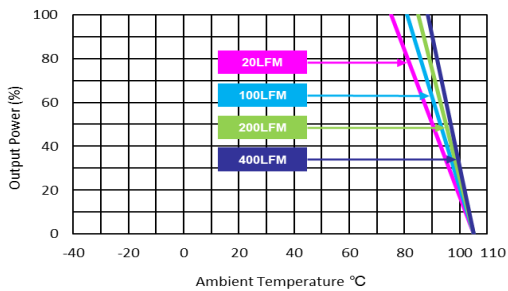

Derating Output Power Versus Ambient Temperature and Airflow  
 $V_{in}=V_{in\ nom}$

**Characteristic Curves**

All test conditions are at 25°C The figures are identical for MJW15-24S033

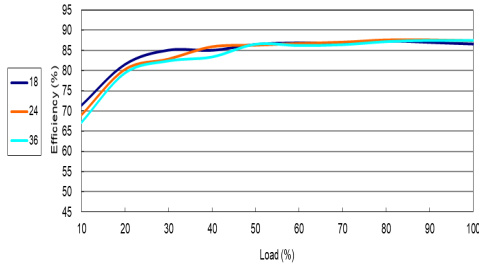

Efficiency Versus Output Current

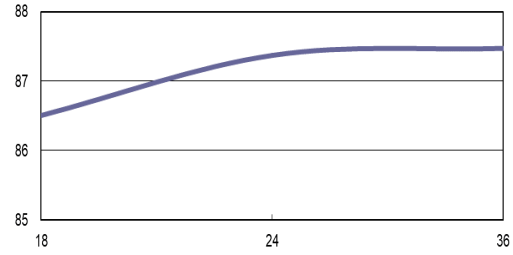

Efficiency Versus Input Voltage Full Load

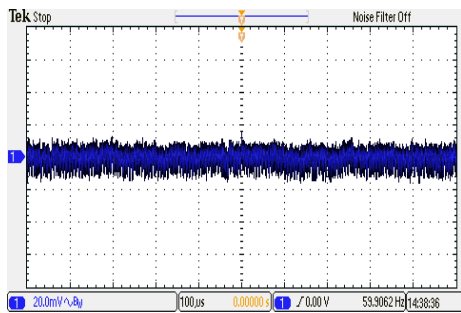

Typical Output Ripple and Noise  
 $V_{in}=V_{in\ nom}$  ; Full Load

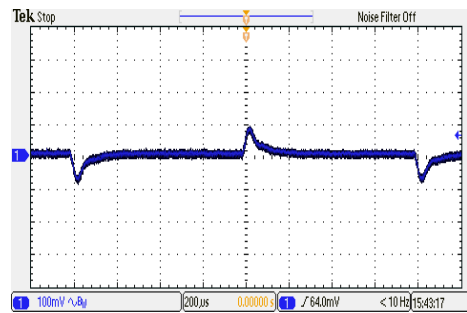

Transient Response to Dynamic Load Change  
from 100% to 75% of Full Load ;  $V_{in}=V_{in\ nom}$

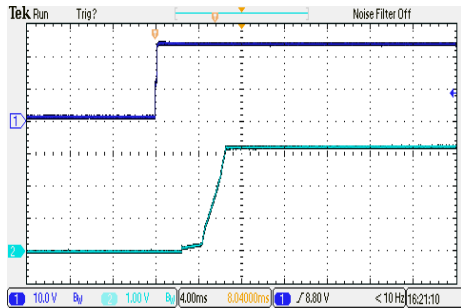

Typical Input Start-Up and Output Rise Characteristic  
 $V_{in}=V_{in\ nom}$  ; Full Load

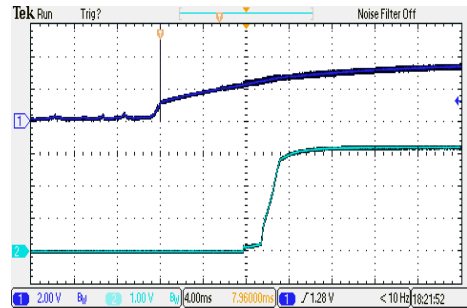

ON/OFF Voltage Start-Up and Output Rise Characteristic  
 $V_{in}=V_{in\ nom}$  ; Full Load

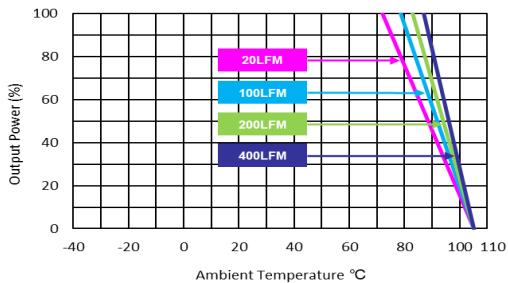

Derating Output Power Versus Ambient Temperature and Airflow  
 $V_{in}=V_{in\ nom}$

**Characteristic Curves**

All test conditions are at 25°C. The figures are identical for MJW15-24S05

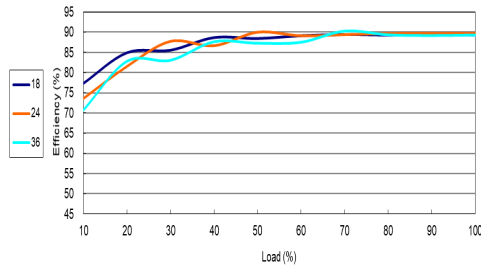

Efficiency Versus Output Current

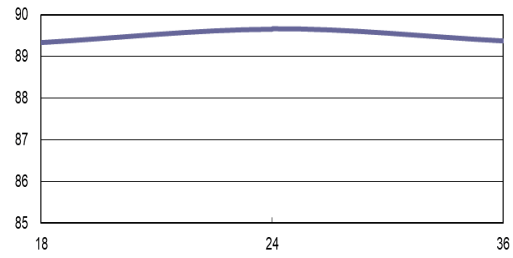

Efficiency Versus Input Voltage Full Load

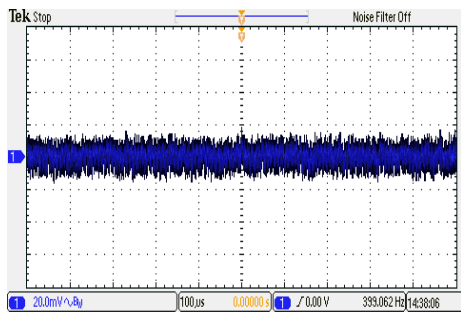

Typical Output Ripple and Noise  
 $V_{in}=V_{in\ nom}$ ; Full Load

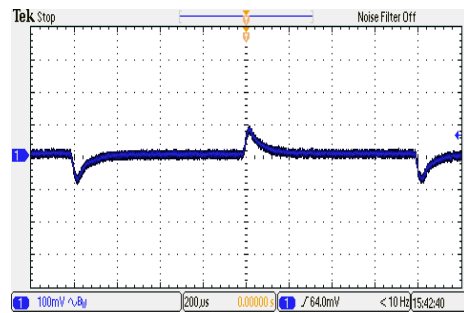

Transient Response to Dynamic Load Change  
from 100% to 75% of Full Load;  $V_{in}=V_{in\ nom}$

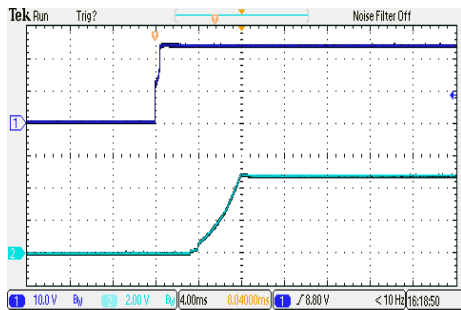

Typical Input Start-Up and Output Rise Characteristic  
 $V_{in}=V_{in\ nom}$ ; Full Load

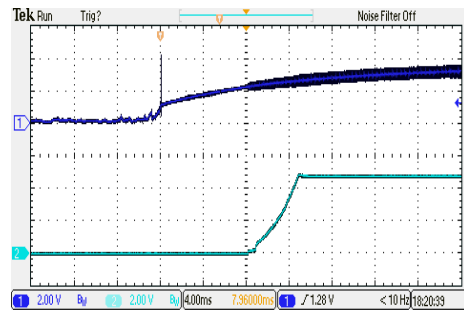

ON/OFF Voltage Start-Up and Output Rise Characteristic  
 $V_{in}=V_{in\ nom}$ ; Full Load

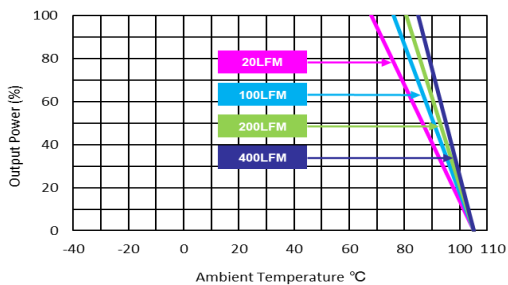

Derating Output Power Versus Ambient Temperature and Airflow  
 $V_{in}=V_{in\ nom}$



**Characteristic Curves**

All test conditions are at 25°C The figures are identical for MJW15-24S12

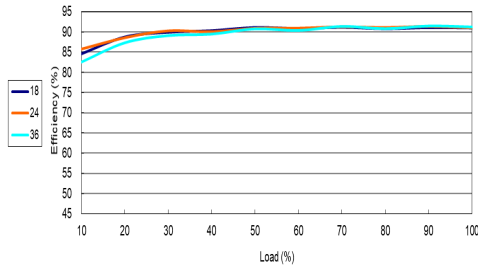

Efficiency Versus Output Current

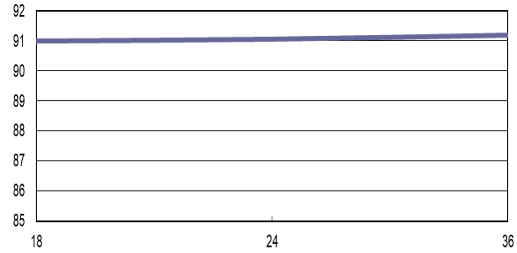

Efficiency Versus Input Voltage Full Load

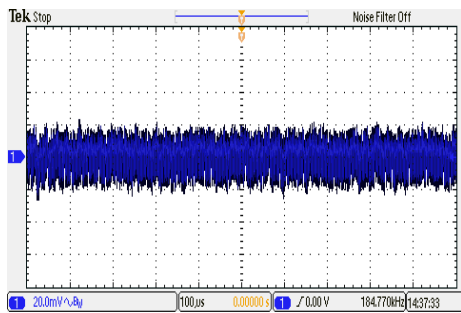

Typical Output Ripple and Noise  
 $V_{in}=V_{in\ nom}$  ; Full Load

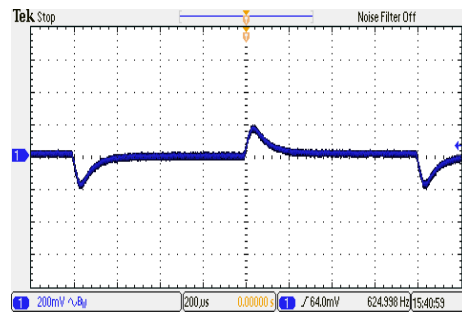

Transient Response to Dynamic Load Change  
from 100% to 75% of Full Load ;  $V_{in}=V_{in\ nom}$

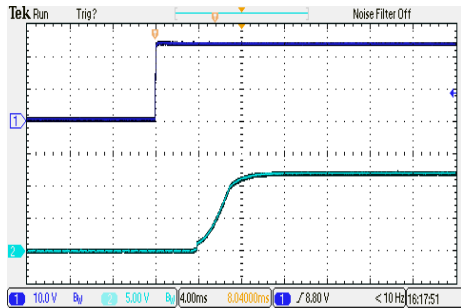

Typical Input Start-Up and Output Rise Characteristic  
 $V_{in}=V_{in\ nom}$  ; Full Load

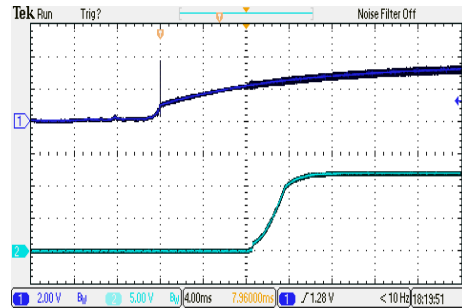

ON/OFF Voltage Start-Up and Output Rise Characteristic  
 $V_{in}=V_{in\ nom}$  ; Full Load

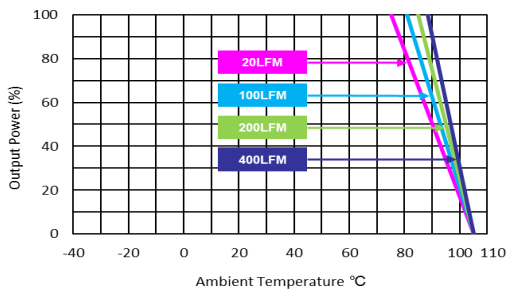

Derating Output Power Versus Ambient Temperature and Airflow  
 $V_{in}=V_{in\ nom}$

**Characteristic Curves**

All test conditions are at 25°C The figures are identical for MJW15-24S15

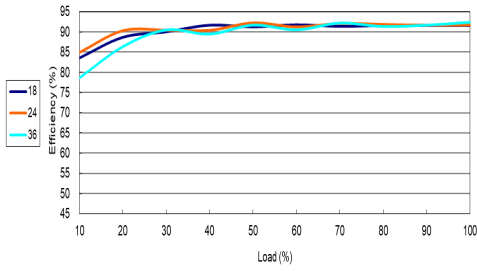

Efficiency Versus Output Current

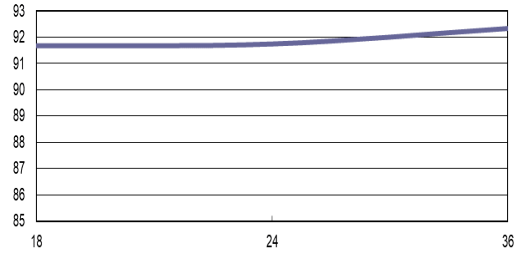

Efficiency Versus Input Voltage Full Load

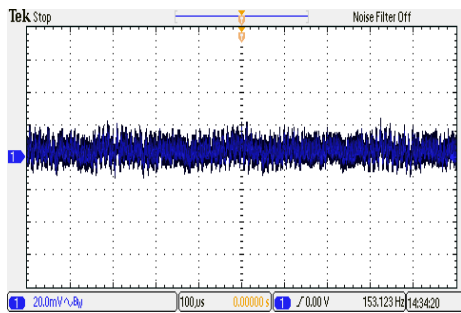

Typical Output Ripple and Noise  
 $V_{in}=V_{in\ nom}$  ; Full Load

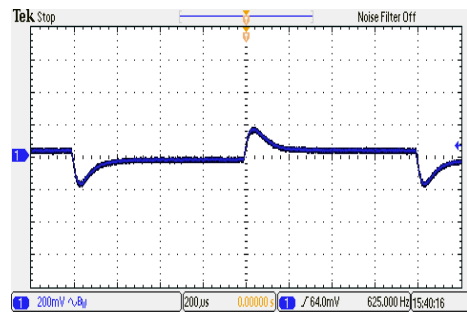

Transient Response to Dynamic Load Change  
from 100% to 75% of Full Load ;  $V_{in}=V_{in\ nom}$

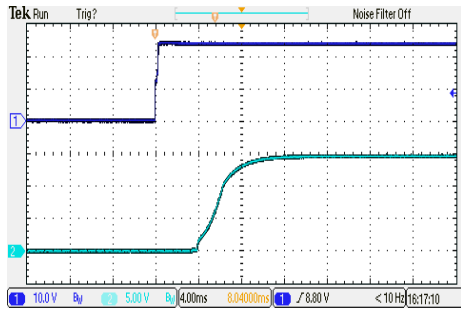

Typical Input Start-Up and Output Rise Characteristic  
 $V_{in}=V_{in\ nom}$  ; Full Load

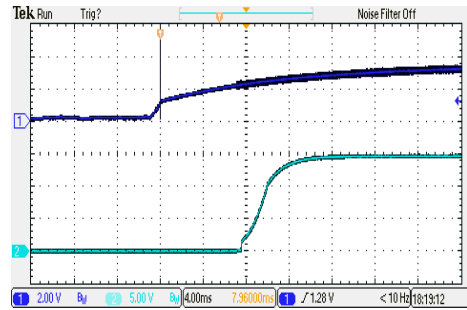

ON/OFF Voltage Start-Up and Output Rise Characteristic  
 $V_{in}=V_{in\ nom}$  ; Full Load

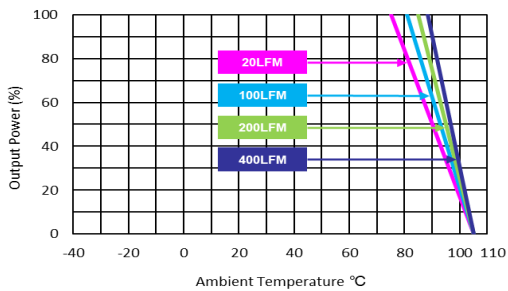

Derating Output Power Versus Ambient Temperature and Airflow  
 $V_{in}=V_{in\ nom}$

**Characteristic Curves**

All test conditions are at 25°C The figures are identical for MJW15-24S24

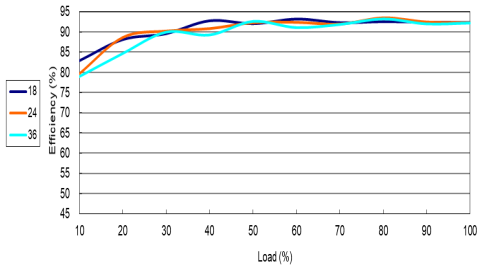

Efficiency Versus Output Current

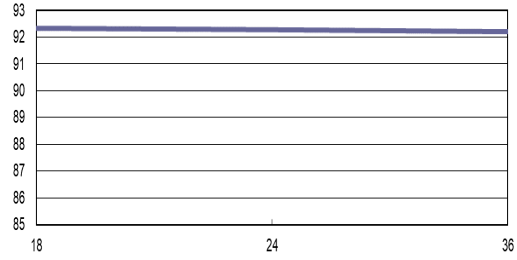

Efficiency Versus Input Voltage Full Load

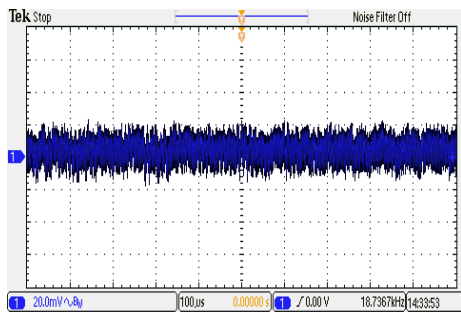

Typical Output Ripple and Noise  
 $V_{in}=V_{in\ nom}$  ; Full Load

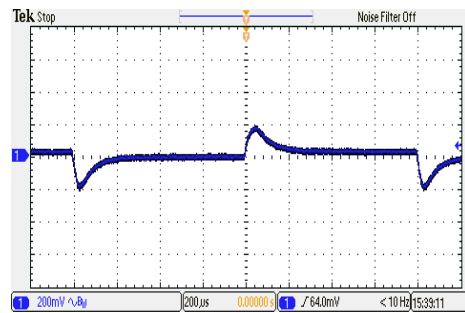

Transient Response to Dynamic Load Change  
from 100% to 75% of Full Load ;  $V_{in}=V_{in\ nom}$

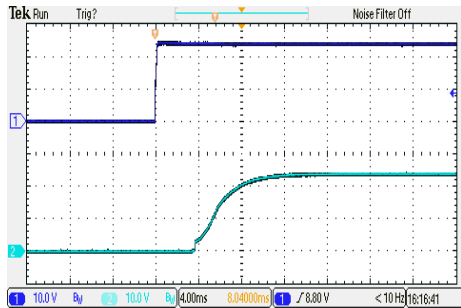

Typical Input Start-Up and Output Rise Characteristic  
 $V_{in}=V_{in\ nom}$  ; Full Load

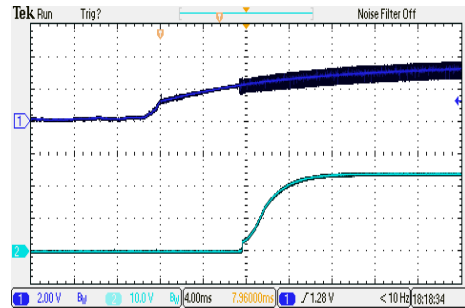

ON/OFF Voltage Start-Up and Output Rise Characteristic  
 $V_{in}=V_{in\ nom}$  ; Full Load

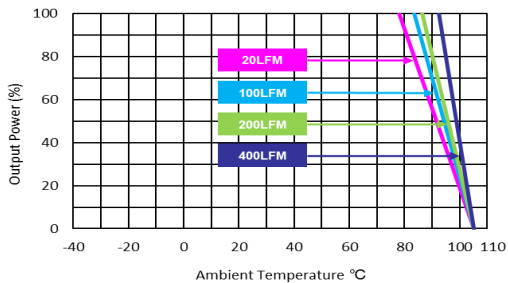

Derating Output Power Versus Ambient Temperature and Airflow  
 $V_{in}=V_{in\ nom}$

**Characteristic Curves**

All test conditions are at 25°C The figures are identical for MJW15-24D12

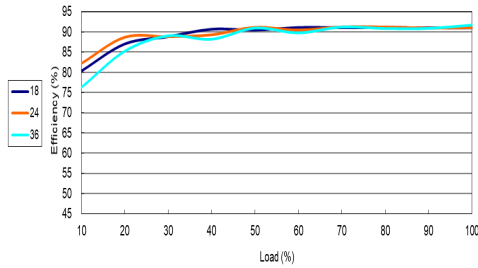

Efficiency Versus Output Current

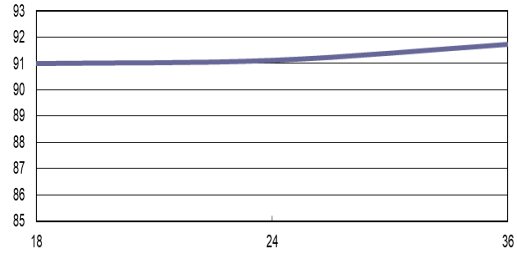

Efficiency Versus Input Voltage Full Load

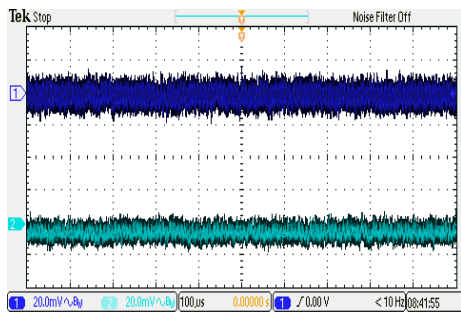

Typical Output Ripple and Noise  
 $V_{in}=V_{in\ nom}$  ; Full Load

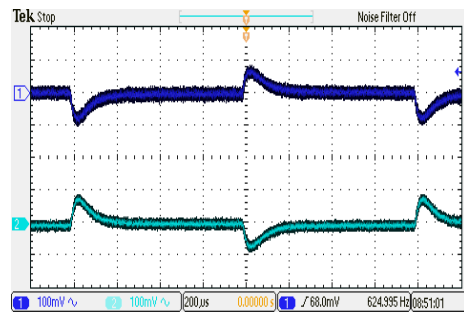

Transient Response to Dynamic Load Change  
from 100% to 75% of Full Load ;  $V_{in}=V_{in\ nom}$

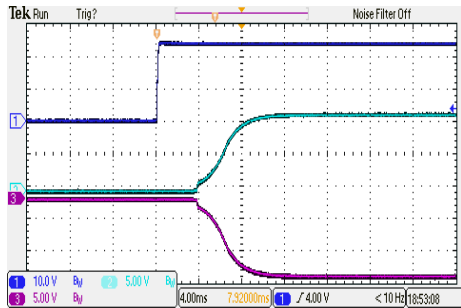

Typical Input Start-Up and Output Rise Characteristic  
 $V_{in}=V_{in\ nom}$  ; Full Load

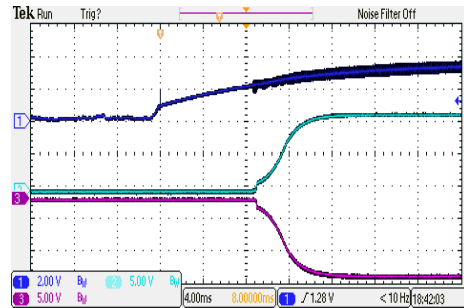

ON/OFF Voltage Start-Up and Output Rise Characteristic  
 $V_{in}=V_{in\ nom}$  ; Full Load

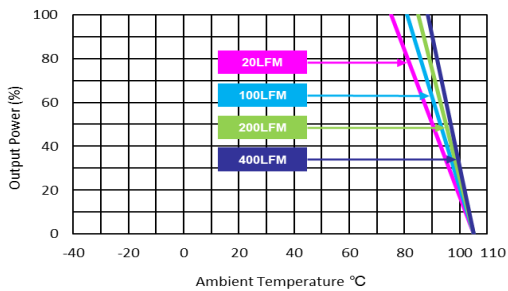

Derating Output Power Versus Ambient Temperature and Airflow  
 $V_{in}=V_{in\ nom}$

**Characteristic Curves**

All test conditions are at 25°C The figures are identical for MJW15-24D15

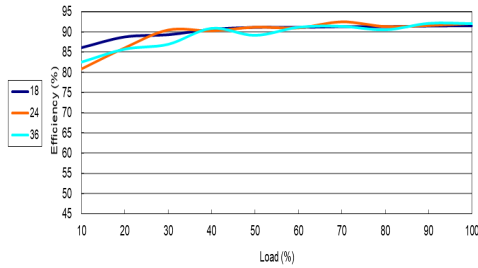

Efficiency Versus Output Current

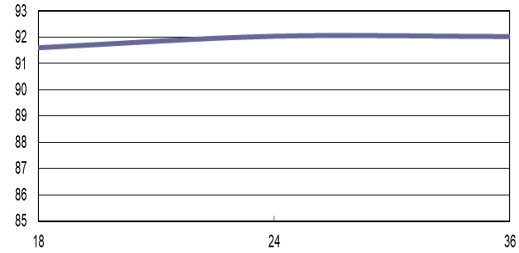

Efficiency Versus Input Voltage Full Load

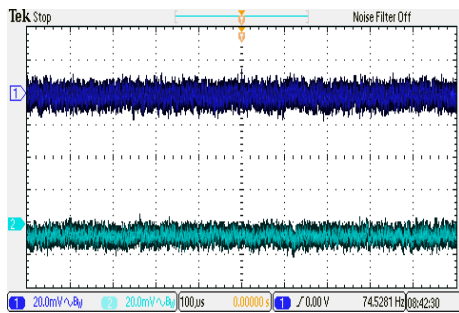

Typical Output Ripple and Noise  
 $V_{in}=V_{in\ nom}$  ; Full Load

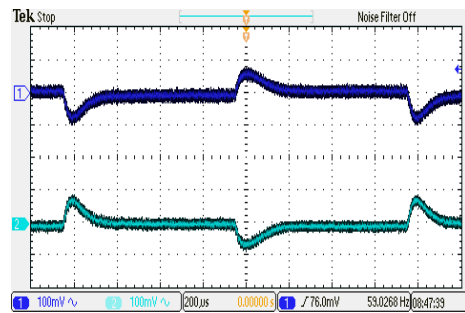

Transient Response to Dynamic Load Change  
from 100% to 75% of Full Load ;  $V_{in}=V_{in\ nom}$

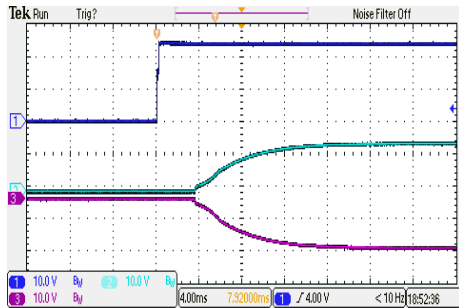

Typical Input Start-Up and Output Rise Characteristic  
 $V_{in}=V_{in\ nom}$  ; Full Load

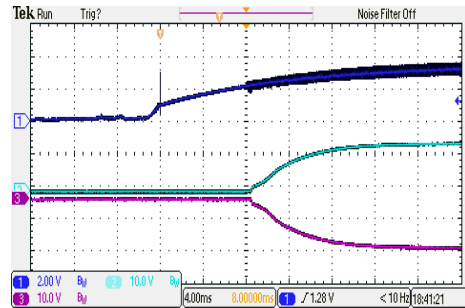

ON/OFF Voltage Start-Up and Output Rise Characteristic  
 $V_{in}=V_{in\ nom}$  ; Full Load

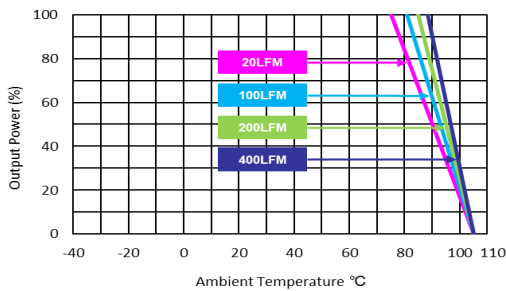

Derating Output Power Versus Ambient Temperature and Airflow  
 $V_{in}=V_{in\ nom}$

**Characteristic Curves**

All test conditions are at 25°C The figures are identical for MJW15-48S033

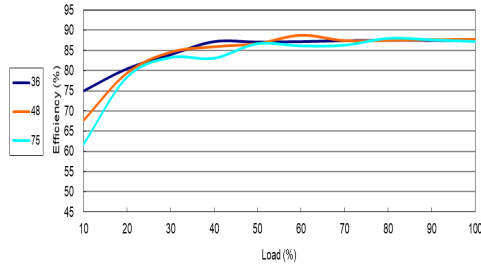

Efficiency Versus Output Current

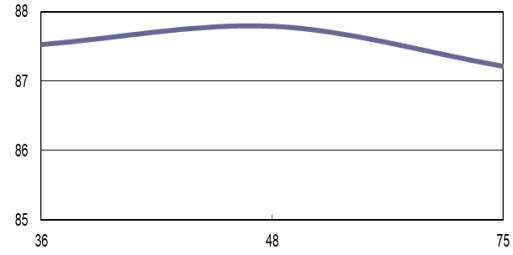

Efficiency Versus Input Voltage Full Load

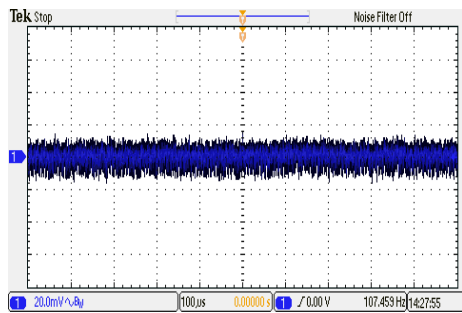

Typical Output Ripple and Noise  
 $V_{in}=V_{in\ nom}$  ; Full Load

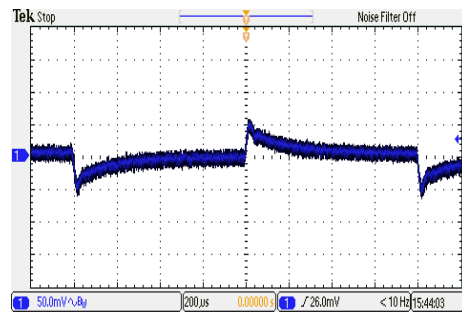

Transient Response to Dynamic Load Change  
from 100% to 75% of Full Load ;  $V_{in}=V_{in\ nom}$

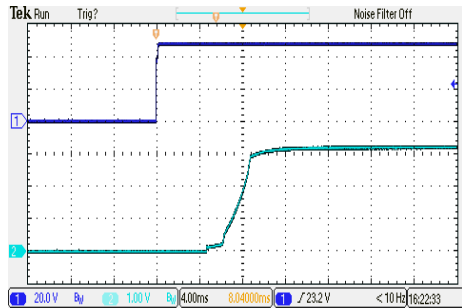

Typical Input Start-Up and Output Rise Characteristic  
 $V_{in}=V_{in\ nom}$  ; Full Load

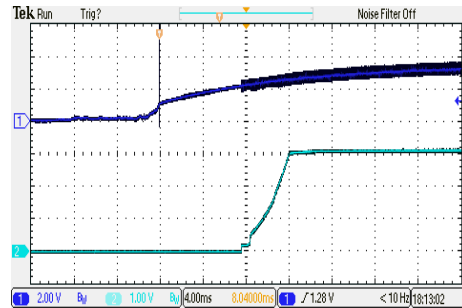

ON/OFF Voltage Start-Up and Output Rise Characteristic  
 $V_{in}=V_{in\ nom}$  ; Full Load

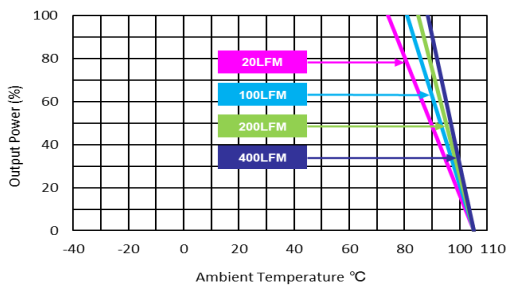

Derating Output Power Versus Ambient Temperature and Airflow  
 $V_{in}=V_{in\ nom}$



**Characteristic Curves**

All test conditions are at 25°C The figures are identical for MJW15-48S05

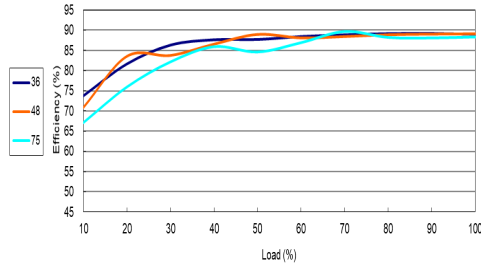

Efficiency Versus Output Current

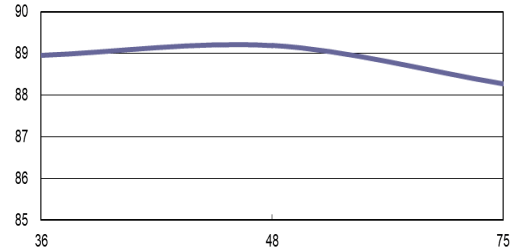

Efficiency Versus Input Voltage Full Load

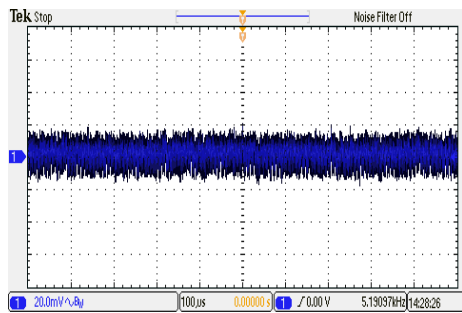

Typical Output Ripple and Noise  
 $V_{in}=V_{in\ nom}$  ; Full Load

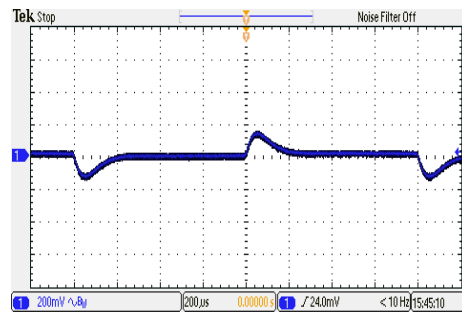

Transient Response to Dynamic Load Change  
from 100% to 75% of Full Load ;  $V_{in}=V_{in\ nom}$

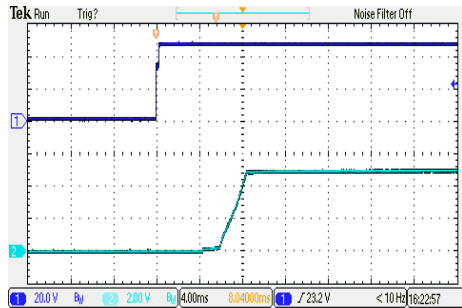

Typical Input Start-Up and Output Rise Characteristic  
 $V_{in}=V_{in\ nom}$  ; Full Load

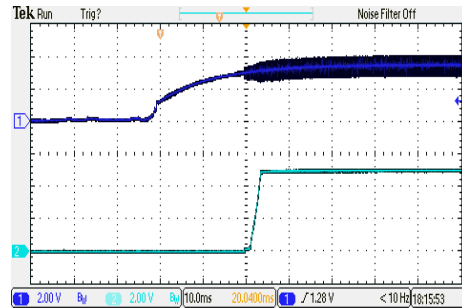

ON/OFF Voltage Start-Up and Output Rise Characteristic  
 $V_{in}=V_{in\ nom}$  ; Full Load

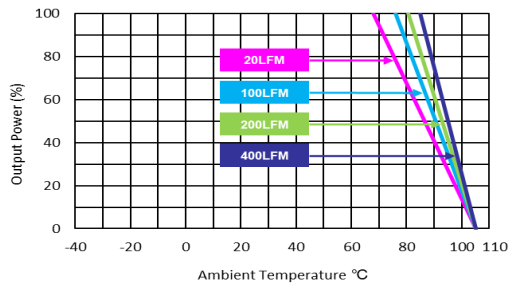

Derating Output Power Versus Ambient Temperature and Airflow  
 $V_{in}=V_{in\ nom}$

**Characteristic Curves**

All test conditions are at 25°C The figures are identical for MJW15-48S12

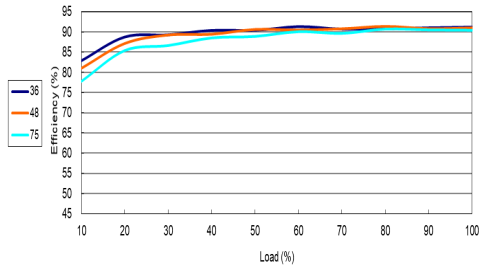

Efficiency Versus Output Current

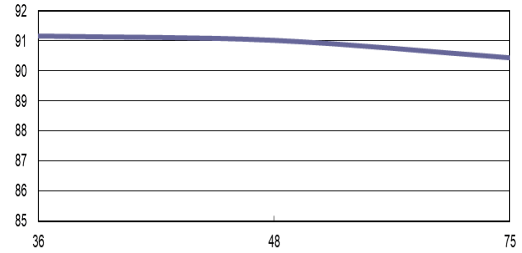

Efficiency Versus Input Voltage Full Load

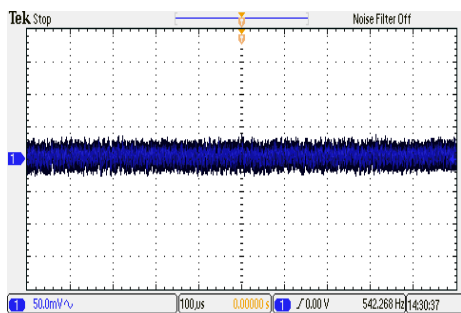

Typical Output Ripple and Noise  
 $V_{in}=V_{in\ nom}$  ; Full Load

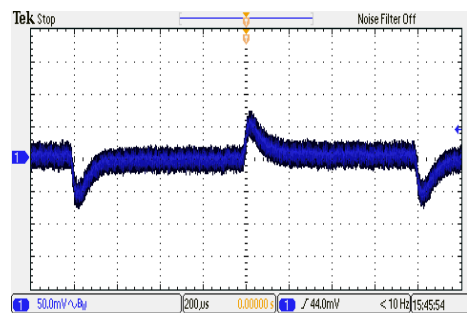

Transient Response to Dynamic Load Change  
from 100% to 75% of Full Load ;  $V_{in}=V_{in\ nom}$

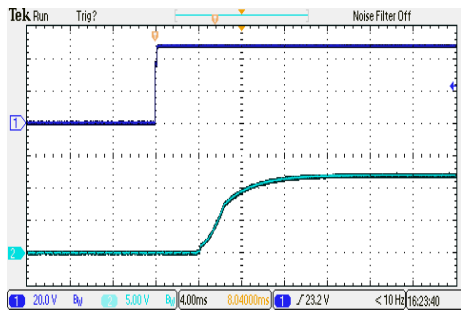

Typical Input Start-Up and Output Rise Characteristic  
 $V_{in}=V_{in\ nom}$  ; Full Load

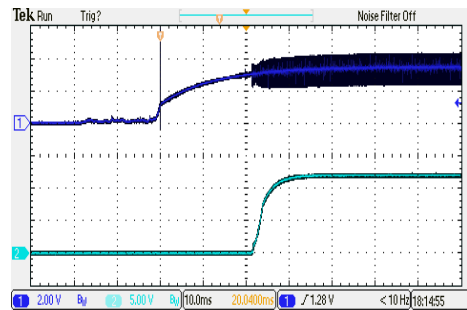

ON/OFF Voltage Start-Up and Output Rise Characteristic  
 $V_{in}=V_{in\ nom}$  ; Full Load

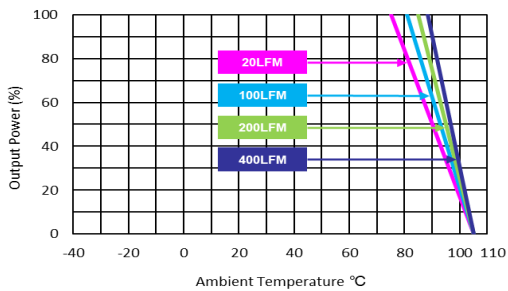

Derating Output Power Versus Ambient Temperature and Airflow  
 $V_{in}=V_{in\ nom}$

**Characteristic Curves**

All test conditions are at 25°C The figures are identical for MJW15-48S15

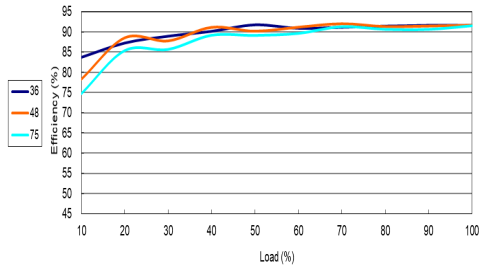

Efficiency Versus Output Current

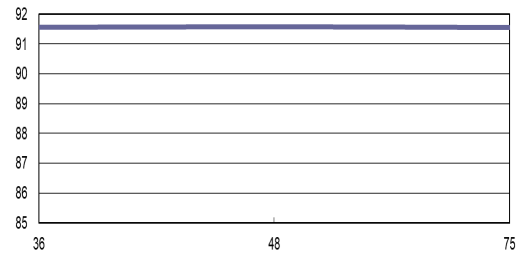

Efficiency Versus Input Voltage Full Load

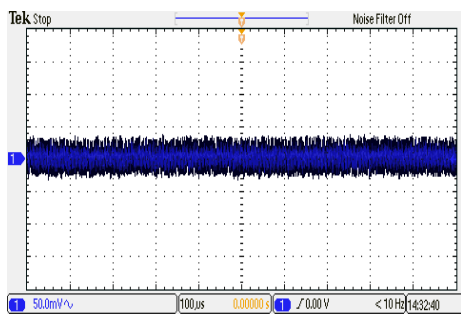

Typical Output Ripple and Noise  
 $V_{in}=V_{in\ nom}$  ; Full Load

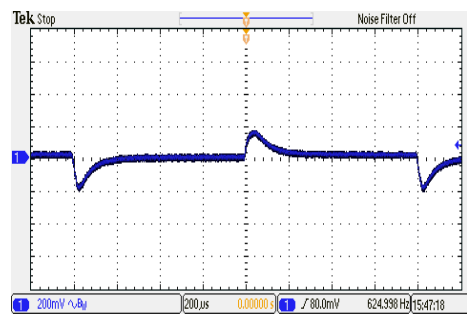

Transient Response to Dynamic Load Change from 100% to 75% of Full Load ;  $V_{in}=V_{in\ nom}$

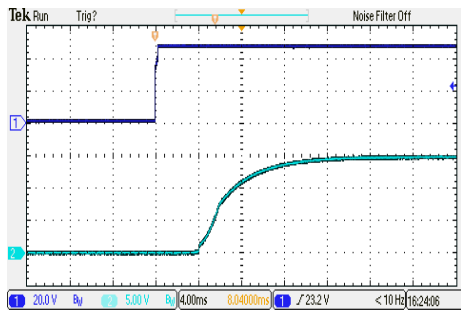

Typical Input Start-Up and Output Rise Characteristic  
 $V_{in}=V_{in\ nom}$  ; Full Load

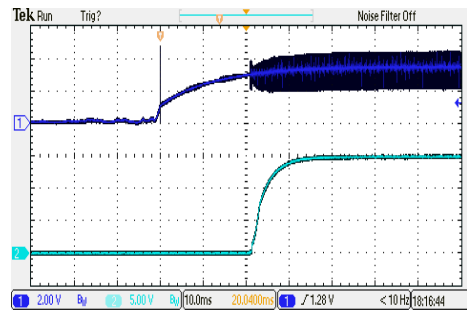

ON/OFF Voltage Start-Up and Output Rise Characteristic  
 $V_{in}=V_{in\ nom}$  ; Full Load

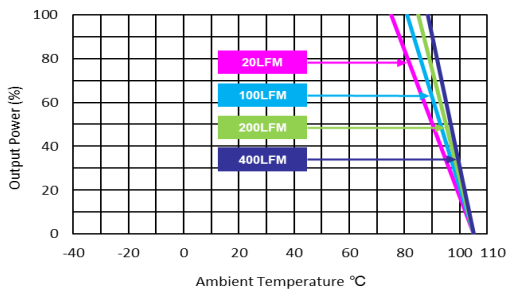

Derating Output Power Versus Ambient Temperature and Airflow  
 $V_{in}=V_{in\ nom}$

**Characteristic Curves**

All test conditions are at 25°C The figures are identical for MJW15-48S24

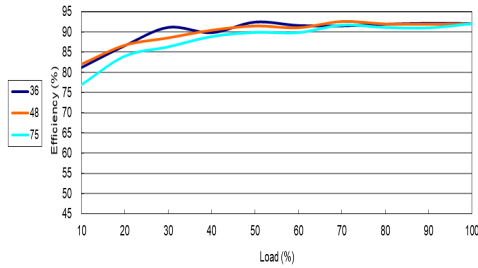

Efficiency Versus Output Current

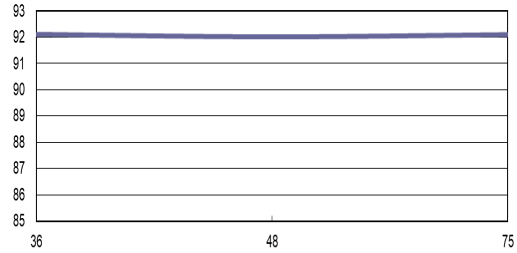

Efficiency Versus Input Voltage Full Load

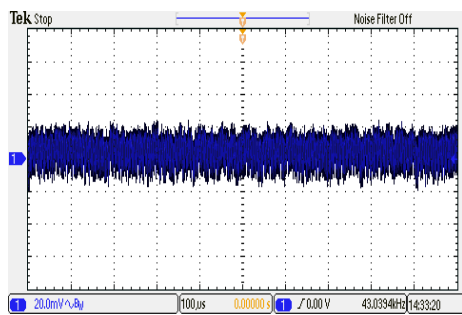

Typical Output Ripple and Noise  
 $V_{in}=V_{in\ nom}$  ; Full Load

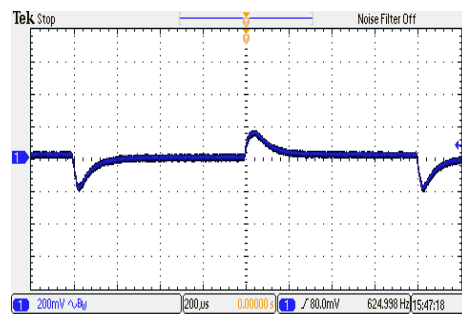

Transient Response to Dynamic Load Change  
from 100% to 75% of Full Load ;  $V_{in}=V_{in\ nom}$

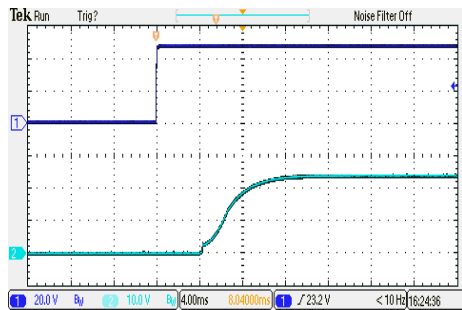

Typical Input Start-Up and Output Rise Characteristic  
 $V_{in}=V_{in\ nom}$  ; Full Load

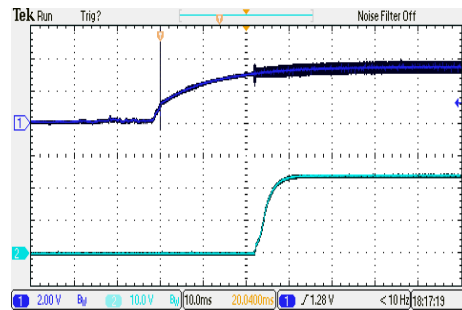

ON/OFF Voltage Start-Up and Output Rise Characteristic  
 $V_{in}=V_{in\ nom}$  ; Full Load

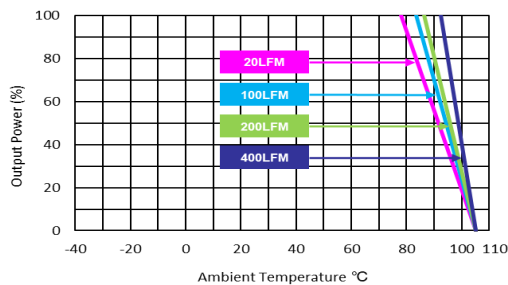

Derating Output Power Versus Ambient Temperature and Airflow  
 $V_{in}=V_{in\ nom}$

**Characteristic Curves**

All test conditions are at 25°C The figures are identical for MJW15-48D12

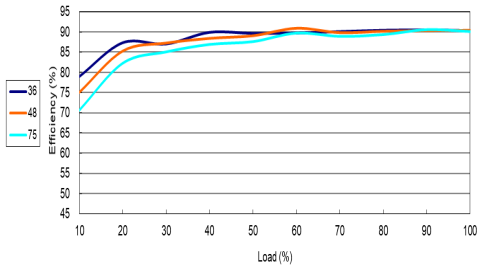

Efficiency Versus Output Current

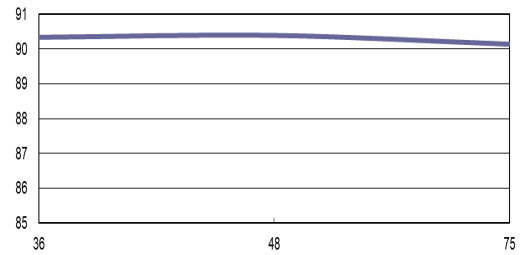

Efficiency Versus Input Voltage Full Load

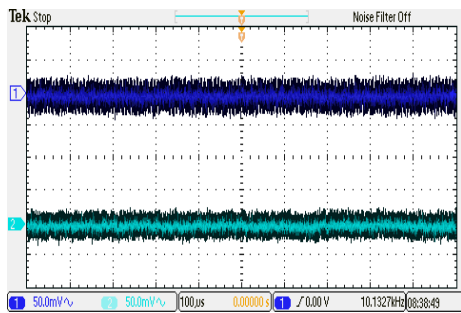

Typical Output Ripple and Noise  
 $V_{in}=V_{in\ nom}$  ; Full Load

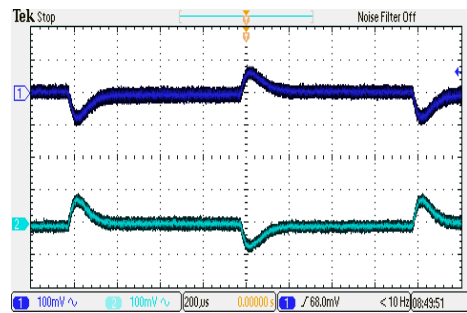

Transient Response to Dynamic Load Change  
from 100% to 75% of Full Load ;  $V_{in}=V_{in\ nom}$

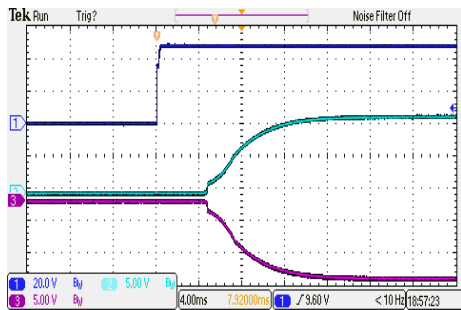

Typical Input Start-Up and Output Rise Characteristic  
 $V_{in}=V_{in\ nom}$  ; Full Load

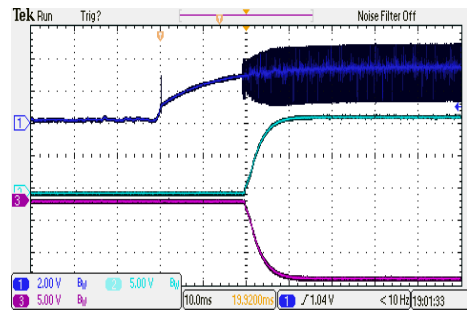

ON/OFF Voltage Start-Up and Output Rise Characteristic  
 $V_{in}=V_{in\ nom}$  ; Full Load

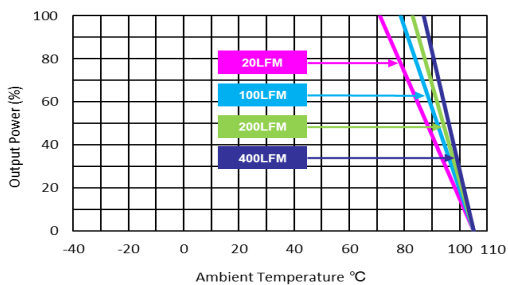

Derating Output Power Versus Ambient Temperature and Airflow  
 $V_{in}=V_{in\ nom}$

**Characteristic Curves**

All test conditions are at 25°C The figures are identical for MJW15-48D15

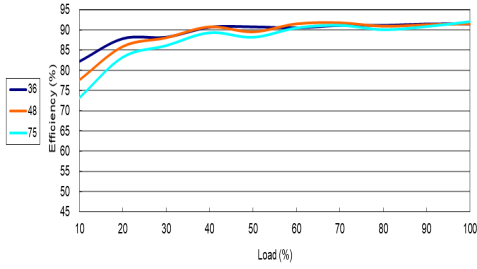

Efficiency Versus Output Current

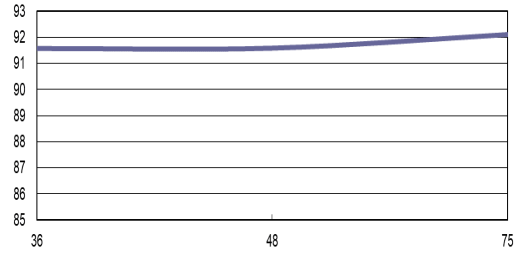

Efficiency Versus Input Voltage Full Load

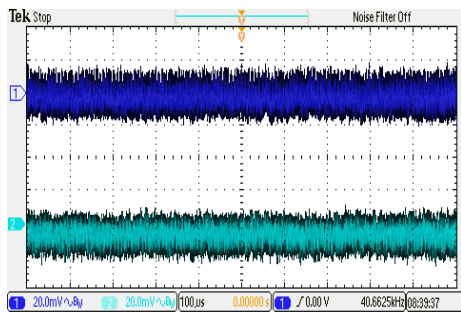

Typical Output Ripple and Noise  
 $V_{in}=V_{in\ nom}$  ; Full Load

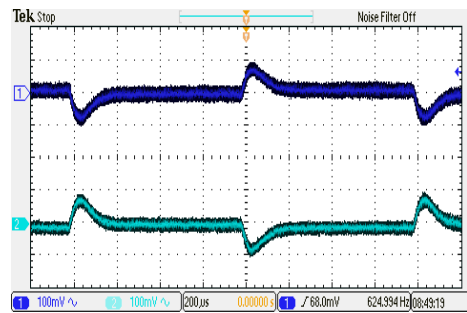

Transient Response to Dynamic Load Change  
from 100% to 75% of Full Load ;  $V_{in}=V_{in\ nom}$

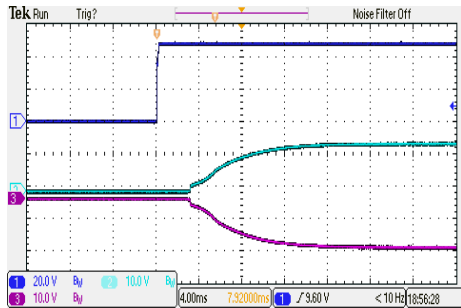

Typical Input Start-Up and Output Rise Characteristic  
 $V_{in}=V_{in\ nom}$  ; Full Load

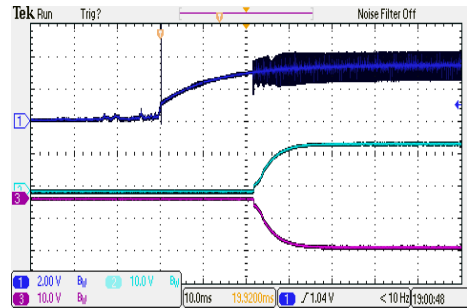

ON/OFF Voltage Start-Up and Output Rise Characteristic  
 $V_{in}=V_{in\ nom}$  ; Full Load

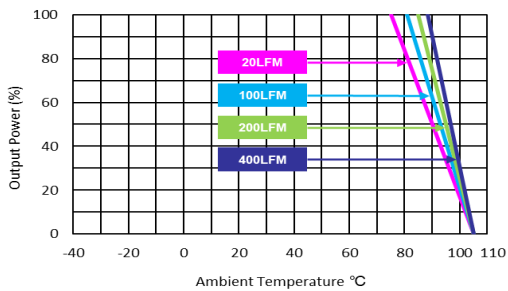

Derating Output Power Versus Ambient Temperature and Airflow  
 $V_{in}=V_{in\ nom}$



### Package Specifications

#### Mechanical Dimensions

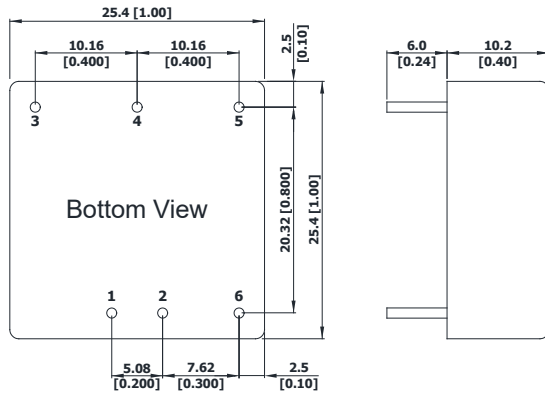

#### Pin Connections

Pin	Single Output	Dual Output	Diameter mm (inches)
1	+Vin	+Vin	Ø 1.0 [0.04]
2	-Vin	-Vin	Ø 1.0 [0.04]
3	+Vout	+Vout	Ø 1.0 [0.04]
4	Trim	Common	Ø 1.0 [0.04]
5	-Vout	-Vout	Ø 1.0 [0.04]
6	Remote On/Off	Remote On/Off	Ø 1.0 [0.04]

- ▶ All dimensions in mm (inches)
- ▶ Tolerance: X.X±0.5 (X.XX±0.02)  
X.XX±0.25 (X.XXX±0.01)
- ▶ Pin diameter tolerance: X.X±0.05 (X.XX±0.002)

### Physical Characteristics

Case Size	: 25.4x25.4x10.2mm (1.0x1.0x0.4 inches)
Case Material	: Metal With Non-Conductive Baseplate
Base Material	: FR4 PCB (flammability to UL 94V-0 rated)
Pin Material	: Copper Alloy
Weight	: 15g

### Heatsink (Option -HS)

#### Mechanical Dimensions

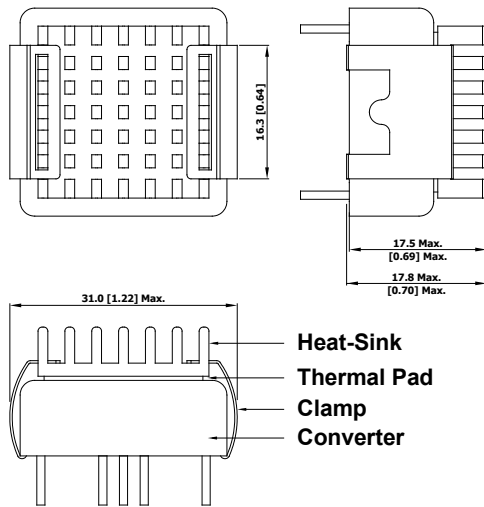

Heatsink Material: Aluminum  
 Finish: Anodic treatment (black)  
 Weight: 2g

- ▶ The advantages of adding a heatsink are:
  1. To improve heat dissipation and increase the stability and reliability of the DC-DC converters at high operating temperatures.
  2. To increase Operating temperature of the DC-DC converter, please refer to Derating Curve.

**Recommended Pad Layout for Single & Dual Output Converter**

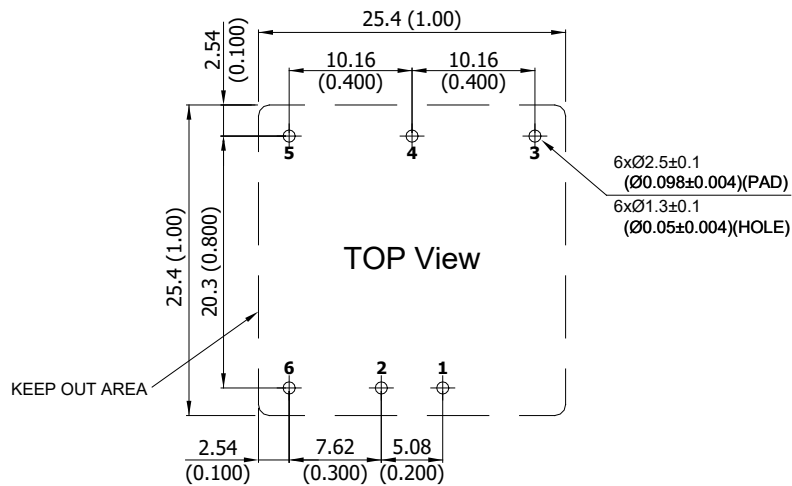

**External Output Trimming**

Output can be externally trimmed by using the method shown below

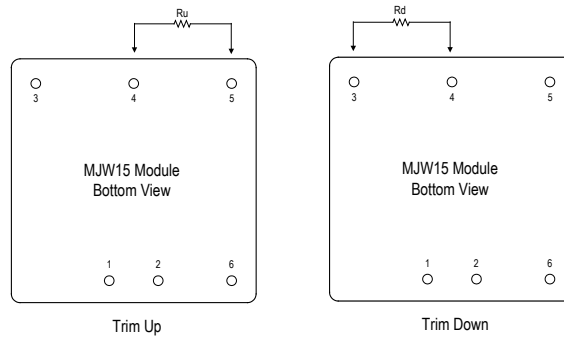

Trim Range (%)	MJW15-XXS033		MJW15-XXS05		MJW15-XXS12		MJW15-XXS15		MJW15-XXS24	
	Trim down (kΩ)	Trim up (kΩ)	Trim down (kΩ)	Trim up (kΩ)	Trim down (kΩ)	Trim up (kΩ)	Trim down (kΩ)	Trim up (kΩ)	Trim down (kΩ)	Trim up (kΩ)
1	72.61	60.84	138.88	106.87	413.55	351.00	530.73	422.77	598.66	487.14
2	32.55	27.40	62.41	47.76	184.55	157.50	238.61	189.89	267.78	218.02
3	19.20	16.25	36.92	28.06	108.22	93.00	141.24	112.26	157.49	128.31
4	12.52	10.68	24.18	18.21	70.05	60.75	92.56	73.44	102.34	83.46
5	8.51	7.34	16.53	12.30	47.15	41.40	63.35	50.15	69.25	56.55
6	5.84	5.11	11.44	8.36	31.88	28.50	43.87	34.63	47.19	38.61
7	3.94	3.51	7.79	5.55	20.98	19.29	29.96	23.54	31.44	25.79
8	2.51	2.32	5.06	3.44	12.80	12.37	19.53	15.22	19.62	16.18
9	1.39	1.39	2.94	1.79	6.44	7.00	11.41	8.75	10.43	8.70
10	0.50	0.65	1.24	0.48	1.35	2.70	4.92	3.58	3.08	2.72

## Test Setup

### Input Reflected-Ripple Current Test Setup

Input reflected-ripple current is measured with an inductor  $L_{in}$  (4.7 $\mu$ H) and  $C_{in}$  (220 $\mu$ F, ESR < 1.0 $\Omega$  at 100 kHz) to simulate source impedance. Capacitor  $C_{in}$ , offsets possible battery impedance. Current ripple is measured at the input terminals of the module, measurement bandwidth is 0-500 kHz.

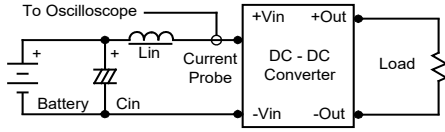

### Peak-to-Peak Output Noise Measurement Test

Use a 1 $\mu$ F ceramic capacitor. Scope measurement should be made by using a BNC socket, measurement bandwidth is 0-20 MHz. Position the load between 50 mm and 75 mm from the DC-DC Converter.

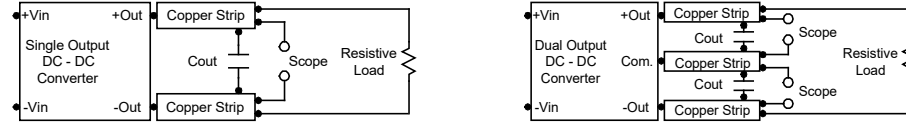

## Technical Notes

### Remote On/Off

Positive logic remote on/off turns the module on during a logic high voltage on the remote on/off pin, and off during a logic low. To turn the power module on and off, the user must supply a switch to control the voltage between the on/off terminal and the -Vin terminal. The switch can be an open collector or equivalent. A logic low is 0V to 1.2V. A logic high is 3.5V to 12V. The maximum sink current at the on/off terminal (Pin 6) during a logic low is -500 $\mu$ A. The maximum allowable leakage current of a switch connected to the on/off terminal (Pin 6) at logic high (3.5V to 12V) is 10mA.

### Overload Protection

To provide hiccup mode protection in a fault (output overload) condition, the unit is equipped with internal current limiting circuitry and can endure overload for an unlimited duration.

### Overvoltage Protection

The output overvoltage clamp consists of control circuitry, which is independent of the primary regulation loop, that monitors the voltage on the output terminals. The control loop of the clamp has a higher voltage set point than the primary loop. This provides a redundant voltage control that reduces the risk of output overvoltage. The OVP level can be found in the output data.

### Input Source Impedance

The power module should be connected to a low ac-impedance input source. Highly inductive source impedances can affect the stability of the power module. In applications where power is supplied over long lines and output loading is high, it may be necessary to use a capacitor at the input to ensure startup. Capacitor mounted close to the power module helps ensure stability of the unit, it is recommended to use a good quality low Equivalent Series Resistance (ESR < 1.0 $\Omega$  at 100 kHz) capacitor of a 10 $\mu$ F for the 24V and 48V devices.

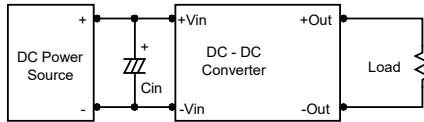

### Output Ripple Reduction

A good quality low ESR capacitor placed as close as practicable across the load will give the best ripple and noise performance. To reduce output ripple, it is recommended to use 4.7 $\mu$ F capacitors at the output.

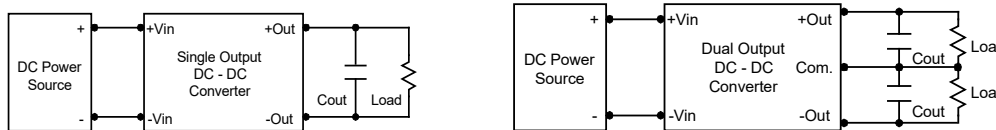

### Maximum Capacitive Load

The MJW15 series has limitation of maximum connected capacitance at the output. The power module may be operated in current limiting mode during start-up, affecting the ramp-up and the startup time. The maximum capacitance can be found in the data sheet.

### Thermal Considerations

Many conditions affect the thermal performance of the power module, such as orientation, airflow over the module and board spacing. To avoid exceeding the maximum temperature rating of the components inside the power module, the case temperature must be kept below 105 $^{\circ}$ C. The derating curves are determined from measurements obtained in a test setup.

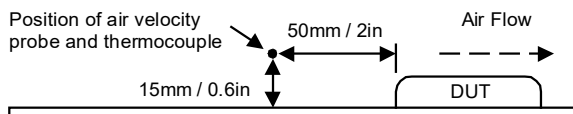

**Remote On/Off Implementation**

The positive logic remote ON/OFF control circuit is included. Turns the module ON during logic High on the ON/Off pin and turns OFF during logic Low. The ON/OFF input signal (Von/off) that referenced to GND. If not using the remote on/off feature, please open circuit between on/off pin and -Vin pin to turn the module on.

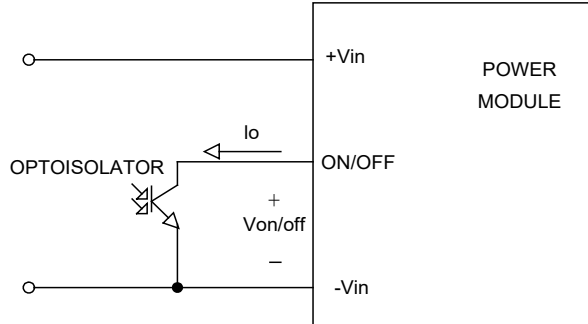

Isolated-Closure Remote ON/OFF

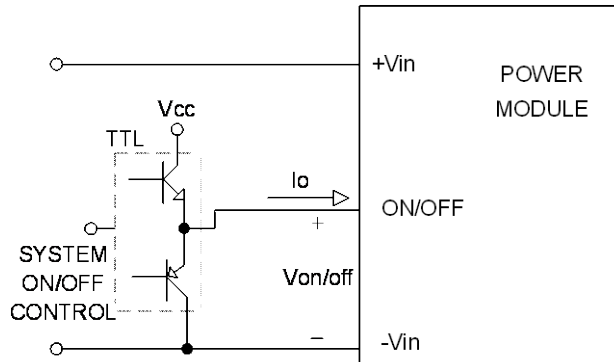

Level Control Using TTL Output

**Packaging Information for Tube**

Tube

Nail

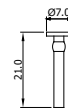
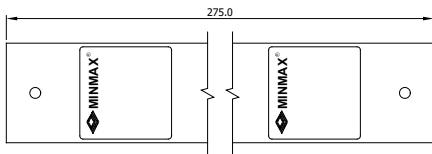
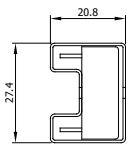

Unit: mm  
10 PCS per TUBE (without Heatsink)

Tube

Plug

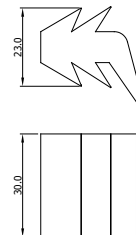
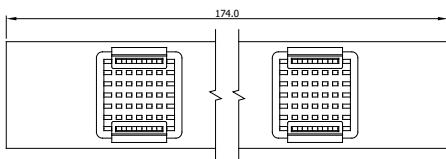
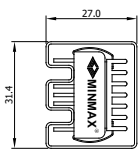

Unit: mm  
5 PCS per TUBE (with Heatsink)

**Wave Soldering Considerations**

Lead free wave solder profile

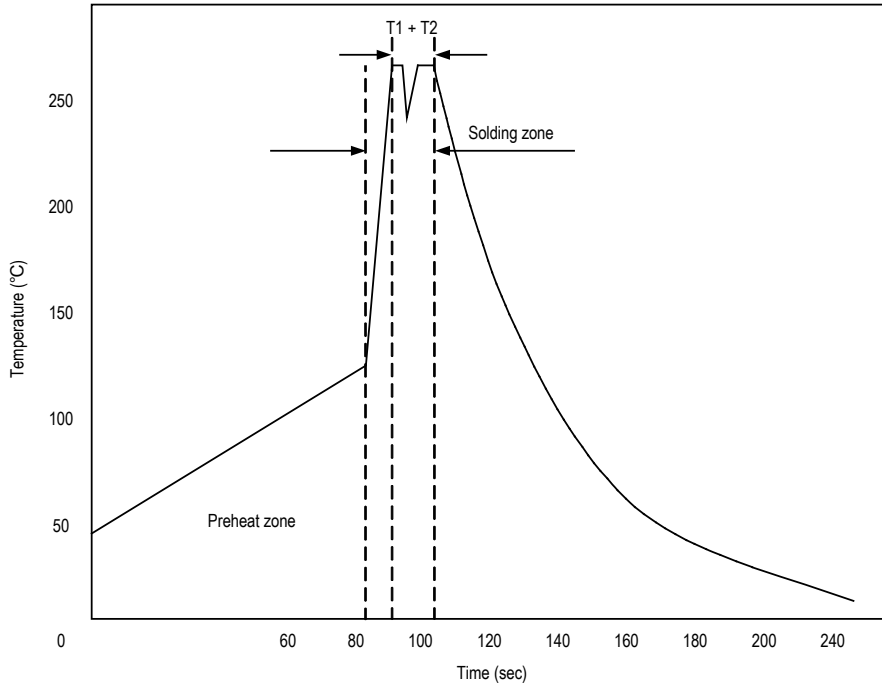

Zone	Reference Parameter
Preheat	Rise temp. speed : 3°C/sec max.
zone	Preheat temp. : 100~130°C
Actual	Peak temp. : 250~260°C
heating	Peak time(T1+T2) : 4~6 sec

**Hand Welding Parameter**

Reference Solder: Sn-Ag-Cu : Sn-Cu : Sn-Ag

Hand Welding: Soldering iron : Power 60W

Welding Time: 2~4 sec

Temp.: 380~400°C

**Part Number Structure**

<b>M</b>	<b>J</b>	<b>W</b>	<b>15</b>	-	<b>12</b>	<b>S</b>	<b>033</b>
Package Type 1" X 1"	Wide 2:1 Input Voltage Range	Output Power 15 Watt	Input Voltage Range			Output Quantity S: Single D: Dual	Output Voltage
			12:	9	~	18	VDC
			24:	18	~	36	VDC
			48:	36	~	75	VDC
			033:	3.3			VDC
			05:	5			VDC
			12:	12			VDC
			15:	15			VDC
			24:	24			VDC

**MTBF and Reliability**

The MTBF of MJW15 series of DC-DC converters has been calculated using

MIL-HDBK 217F NOTICE2, Operating Temperature 25°C, Ground Benign.

Model	MTBF	Unit
MJW15-12S033	1,504,901	Hours
MJW15-12S05	1,564,437	
MJW15-12S12	2,191,727	
MJW15-12S15	2,012,405	
MJW15-12S24	2,318,844	
MJW15-12D12	1,883,245	
MJW15-12D15	1,878,991	
MJW15-24S033	1,542,221	
MJW15-24S05	1,489,680	
MJW15-24S12	2,375,076	
MJW15-24S15	2,252,961	
MJW15-24S24	2,448,672	
MJW15-24D12	1,996,727	
MJW15-24D15	1,901,442	
MJW15-48S033	1,654,078	
MJW15-48S05	1,499,286	
MJW15-48S12	2,396,657	
MJW15-48S15	2,330,863	
MJW15-48S24	2,548,599	
MJW15-48D12	1,883,151	
MJW15-48D15	1,949,380	