



MINMAX[®]

MCWI02 Series

Electric Characteristic Note

MCWI02 Series EC Note

DC-DC CONVERTER 2W, SIP Package

Features

- ▶ Industrial Standard SIP-8 Package
- ▶ Ultra-wide 4 : 1 Input Voltage Range
- ▶ Fully Regulated Output Voltage
- ▶ I/O Isolation 1500 VDC
- ▶ Operating Ambient Temp. Range -40°C to +90°C
- ▶ No Min. Load Requirement
- ▶ Overload and Short Circuit Protection
- ▶ Remote On/Off Control
- ▶ UL/cUL/IEC/EN 62368-1(60950-1) Safety Approval & CE Marking



Applications

- ▶ Distributed power architectures
- ▶ Workstations
- ▶ Computer equipment
- ▶ Communications equipment

Product Overview

The MINMAX MCWI02 series is a range of isolated 2W DC-DC converter modules featuring fully regulated output and ultra-wide 4:1 input voltage ranges. The product comes in a SIP-8 package with a very small footprint occupying only 2.0 cm² (0.32 square in.) on the PCB.

An excellent efficiency allows an operating temperature range up to 90°C at full load. Further features include remote On/Off control, short circuit and over load protection.

The very compact dimensions of these DC-DC converters make them an ideal solution for many space critical applications in battery-powered equipment and instrumentation.

Table of contents

Model Selection Guide	P2	Recommended Pad Layout for Single & Dual Output Converter.....	P25
Input Specifications.....	P2	Test Setup.....	P26
Remote On/Off Control.....	P2	Technical Notes	P26
Output Specifications.....	P3	Remote On/Off Implementation.....	P27
General Specifications.....	P3	Packaging Information for Tube	P27
EMC Specifications.....	P3	Wave Soldering Considerations	P28
Environmental Specifications	P3	Hand Welding Parameter	P28
Characteristic Curves	P4	Part Number Structure	P29
Package Specifications	P25	MTBF and Reliability	P29

Model Selection Guide

Model Number	Input Voltage (Range)	Output Voltage	Output Current	Input Current		Max. capacitive Load	Efficiency (typ.)
				Max.	@No Load		
	VDC	VDC	mA	@Max. Load mA(typ.)	@No Load mA(typ.)	μF	@Max. Load %
MCWI02-12S033	12 (4.5 ~ 18)	3.3	500	183	60	1000	75
MCWI02-12S05		5	400	208		1000	80
MCWI02-12S12		12	167	204		170	82
MCWI02-12S15		15	134	204		110	82
MCWI02-12D05		±5	±200	208		470#	80
MCWI02-12D12		±12	±83	202		100#	82
MCWI02-12D15		±15	±67	204		47#	82
MCWI02-24S033	24 (9 ~ 36)	3.3	500	92	30	1000	75
MCWI02-24S05		5	400	104		1000	80
MCWI02-24S12		12	167	102		170	82
MCWI02-24S15		15	134	102		110	82
MCWI02-24D05		±5	±200	104		470#	80
MCWI02-24D12		±12	±83	101		100#	82
MCWI02-24D15		±15	±67	102		47#	82
MCWI02-48S033	48 (18 ~ 75)	3.3	500	46	20	1000	74
MCWI02-48S05		5	400	52		1000	80
MCWI02-48S12		12	167	51		170	82
MCWI02-48S15		15	134	51		110	82
MCWI02-48D05		±5	±200	52		470#	80
MCWI02-48D12		±12	±83	51		100#	82
MCWI02-48D15		±15	±67	51		47#	82

For each output

Input Specifications

Parameter	Model	Min.	Typ.	Max.	Unit
Input Surge Voltage (1 sec. max.)	12V Input Models	-0.7	---	25	VDC
	24V Input Models	-0.7	---	50	
	48V Input Models	-0.7	---	100	
Start-Up Threshold Voltage	12V Input Models	3	4	4.5	
	24V Input Models	4.5	6	9	
	48V Input Models	8.5	12	18	
Under Voltage Shutdown	12V Input Models	---	---	4	
	24V Input Models	---	---	8	
	48V Input Models	---	---	16	
Short Circuit Input Power	All Models	---	---	1500	mW
Input Filter		Internal Capacitor			

Remote On/Off Control

Parameter	Conditions	Min.	Typ.	Max.	Unit
Converter On	Under 0.6 VDC or Open Circuit				
Converter Off	4.7 to 15 VDC				
Standby Input Current	Nominal Vin	---	---	3	mA

Output Specifications

Parameter	Conditions	Min.	Typ.	Max.	Unit
Output Voltage Setting Accuracy		---	---	±2.0	%Vnom.
Output Voltage Balance	Dual Output, Balanced Loads	---	±1.0	±2.0	%
Line Regulation	Vin=Min. to Max. @Full Load	---	±0.3	±0.5	%
Load Regulation	Io=0% to 100%	---	±0.5	±1.0	%
Minimum Load	No minimum Load Requirement				
Ripple & Noise	0-20MHz Bandwidth	---	---	100	mV _{P-P}
Transient Recovery Time	25% Load Step Change	---	300	500	µsec
Transient Response Deviation		---	±3	±5	%
Temperature Coefficient		---	±0.01	±0.02	%/°C
Over Load Protection	Foldback	110	140	---	%
Output Short Circuit	Continuous, Automatic Recovery				

General Specifications

Parameter	Conditions	Min.	Typ.	Max.	Unit
I/O Isolation Voltage	60 Seconds	1500	---	---	VDC
	1 Second	1800	---	---	VDC
I/O Isolation Resistance	500 VDC	1000	---	---	MΩ
I/O Isolation Capacitance	100kHz, 1V	---	250	500	pF
Switching Frequency		---	300	---	kHz
MTBF (Calculated)	MIL-HDBK-217F@25°C, Ground Benign	3,430,000	---	---	Hours
Safety Approvals	UL/cUL 60950-1 recognition(CSA certificate), IEC/EN 60950-1(CB-scheme)				
	UL/cUL 62368-1 recognition(UL certificate), IEC/EN 62368-1(CB-report)				

EMC Specifications

Parameter	Standards & Level			Performance
EMI ₍₅₎	Conduction	EN 55032	With external components	Class A
	Radiation		With external components	
EMS ₍₅₎	EN 55035			
	ESD	EN 61000-4-2 Air ± 8kV , Contact ± 4kV		A
	Radiated immunity	EN 61000-4-3 10V/m		A
	Fast transient	EN 61000-4-4 ±2kV		A
	Surge	EN 61000-4-5 ±1kV		A
	Conducted immunity	EN 61000-4-6 10Vrms		A
	PFMF	EN 61000-4-8 100A/m		A

Environmental Specifications

Parameter	Min.	Max.	Unit
Operating Ambient Temperature Range (See Power Derating Curve)	-40	+90	°C
Case Temperature	---	+105	°C
Storage Temperature Range	-55	+125	°C
Humidity (non condensing)	---	95	% rel. H
Lead Temperature (1.5mm from case for 10Sec.)	---	260	°C

Notes

- Specifications typical at Ta=+25°C, resistive load, nominal input voltage and rated output current unless otherwise noted.
- Transient recovery time is measured to within 1% error band for a step change in output load of 75% to 100%.
- We recommend to protect the converter by a slow blow fuse in the input supply line.
- Other input and output voltage may be available, please contact MINMAX.
- The external components might be required to meet EMI/EMS standard for some of test items. Please contact MINMAX for the solution in detail.
- Specifications are subject to change without notice.

Characteristic Curves

All test conditions are at 25°C The figures are identical for MCWI02-12S033

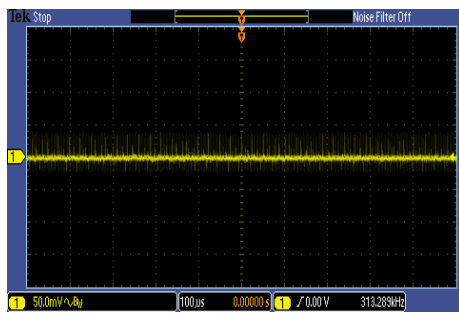
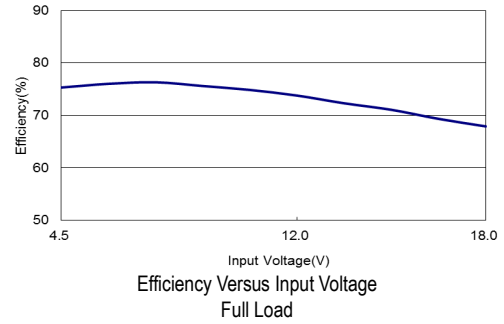
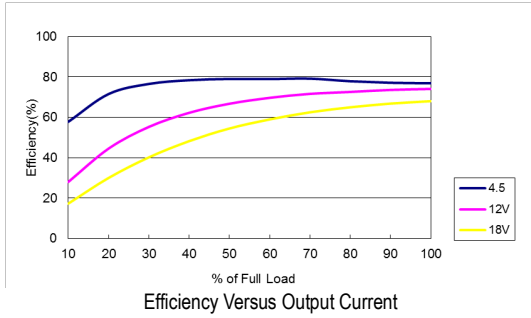

Typical Output Ripple and Noise
 $V_{in}=V_{in\ nom}$; Full Load

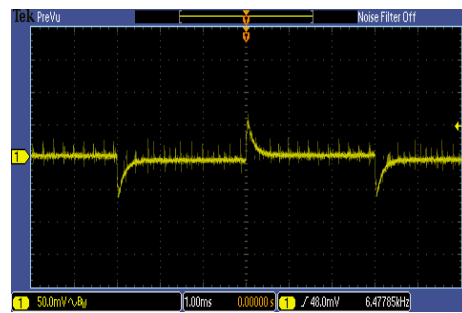

Transient Response to Dynamic Load Change
from 100% to 75% of Full Load ; $V_{in}=V_{in\ nom}$

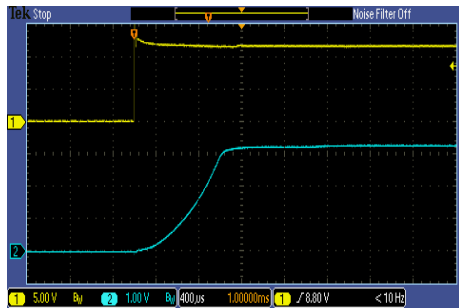

Typical Input Start-Up and Output Rise Characteristic
 $V_{in}=V_{in\ nom}$; Full Load

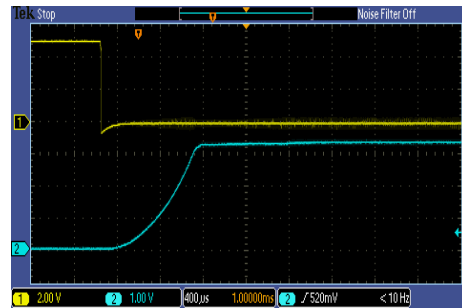

ON/OFF Voltage Start-Up and Output Rise Characteristic
 $V_{in}=V_{in\ nom}$; Full Load

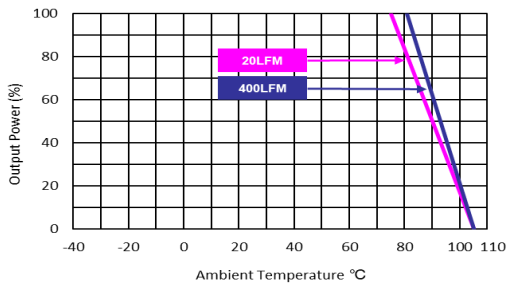

Derating Output Current Versus Ambient Temperature and Airflow
 $V_{in}=V_{in\ nom}$

Characteristic Curves

All test conditions are at 25°C The figures are identical for MCWI02-12S05

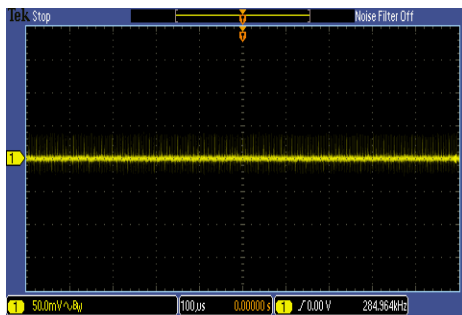
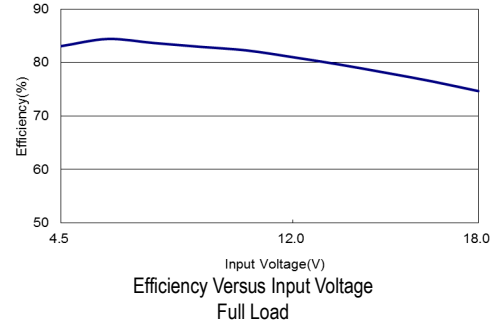
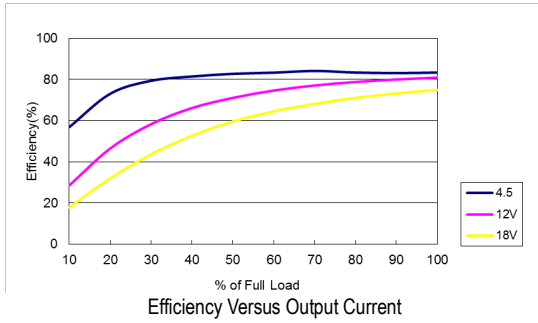

Typical Output Ripple and Noise
 $V_{in}=V_{in\ nom}$; Full Load

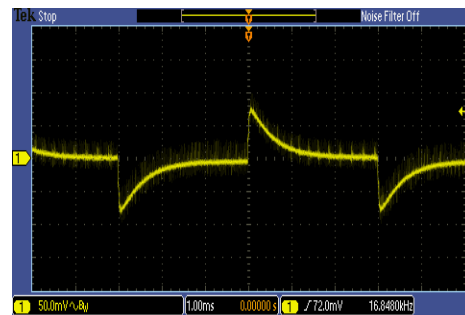

Transient Response to Dynamic Load Change
from 100% to 75% of Full Load ; $V_{in}=V_{in\ nom}$

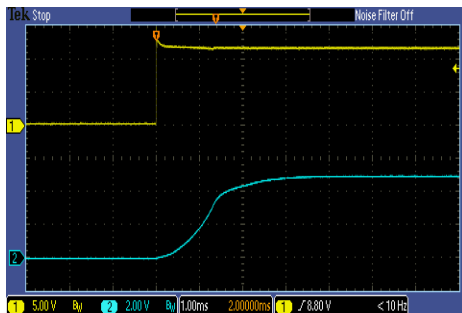

Typical Input Start-Up and Output Rise Characteristic
 $V_{in}=V_{in\ nom}$; Full Load

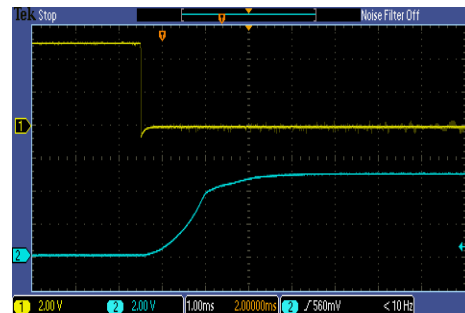

ON/OFF Voltage Start-Up and Output Rise Characteristic
 $V_{in}=V_{in\ nom}$; Full Load

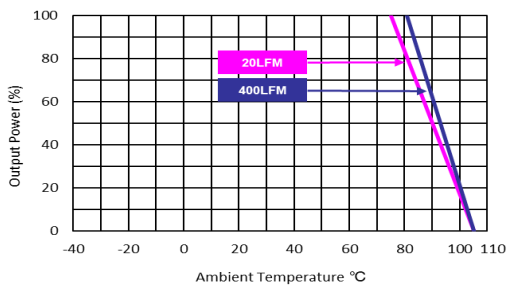

Derating Output Current Versus Ambient Temperature and Airflow
 $V_{in}=V_{in\ nom}$

Characteristic Curves

All test conditions are at 25°C The figures are identical for MCWI02-12S12

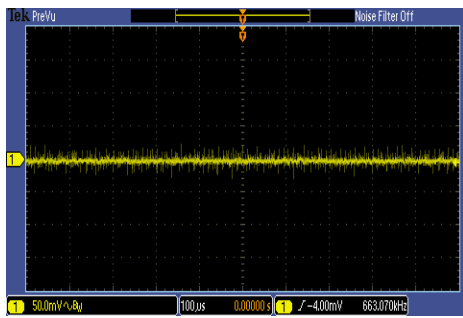
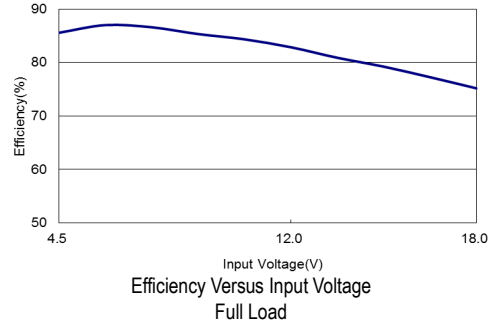
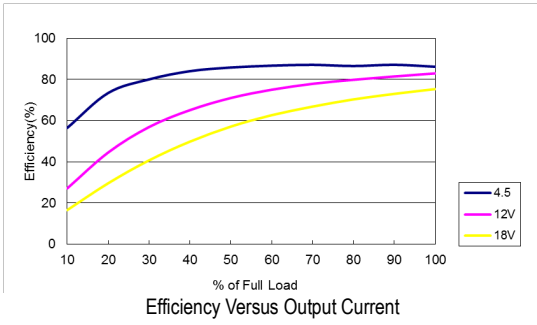

Typical Output Ripple and Noise
 $V_{in}=V_{in\ nom}$; Full Load

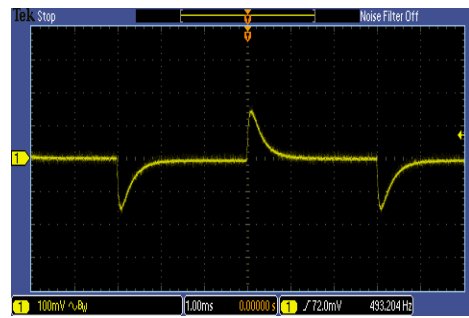

Transient Response to Dynamic Load Change
from 100% to 75% of Full Load ; $V_{in}=V_{in\ nom}$

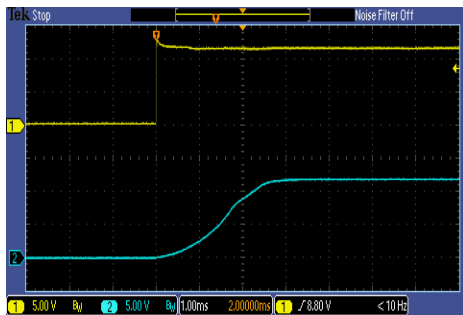

Typical Input Start-Up and Output Rise Characteristic
 $V_{in}=V_{in\ nom}$; Full Load

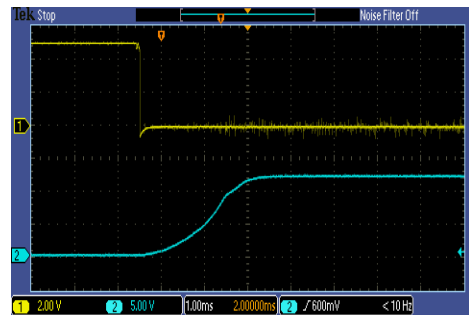

ON/OFF Voltage Start-Up and Output Rise Characteristic
 $V_{in}=V_{in\ nom}$; Full Load

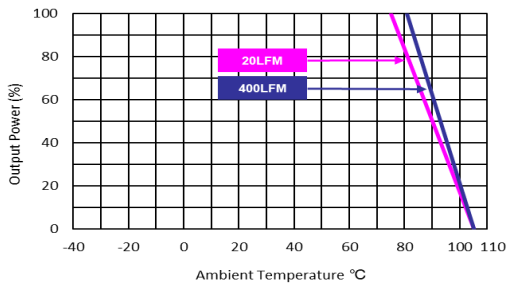

Derating Output Current Versus Ambient Temperature and Airflow
 $V_{in}=V_{in\ nom}$

Characteristic Curves

All test conditions are at 25°C The figures are identical for MCWI02-12S15

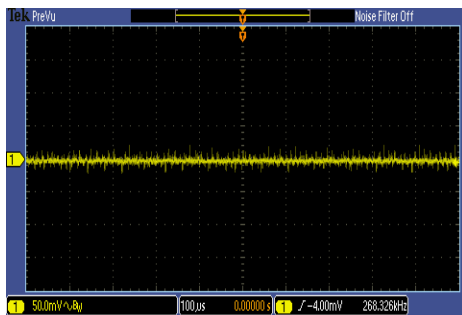
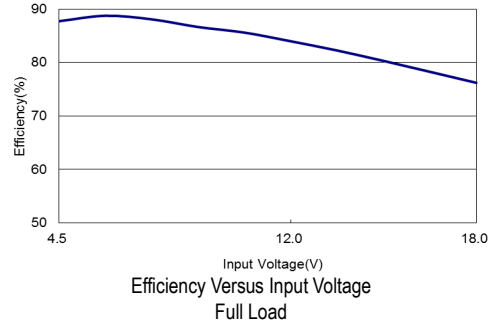
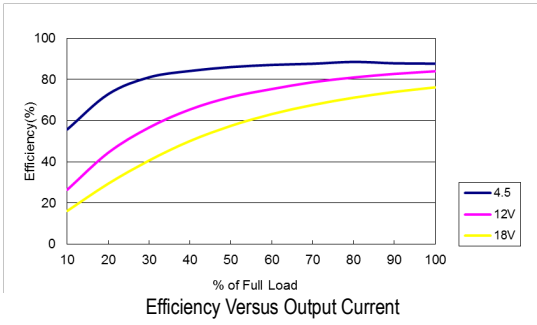

Typical Output Ripple and Noise
 $V_{in}=V_{in\ nom}$; Full Load

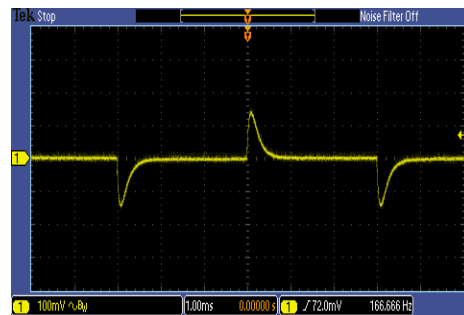

Transient Response to Dynamic Load Change
from 100% to 75% of Full Load ; $V_{in}=V_{in\ nom}$

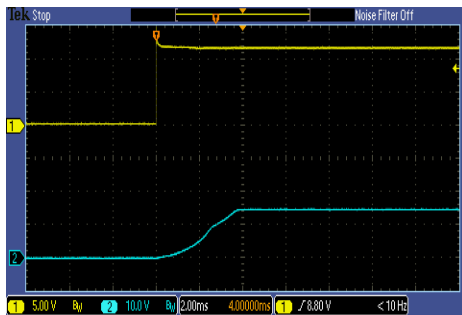

Typical Input Start-Up and Output Rise Characteristic
 $V_{in}=V_{in\ nom}$; Full Load

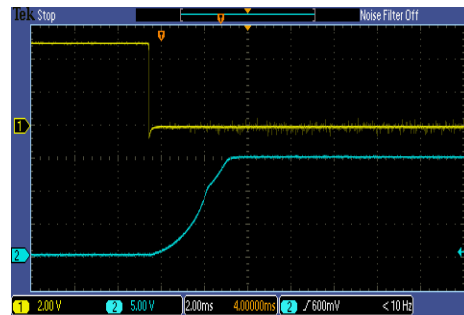

ON/OFF Voltage Start-Up and Output Rise Characteristic
 $V_{in}=V_{in\ nom}$; Full Load

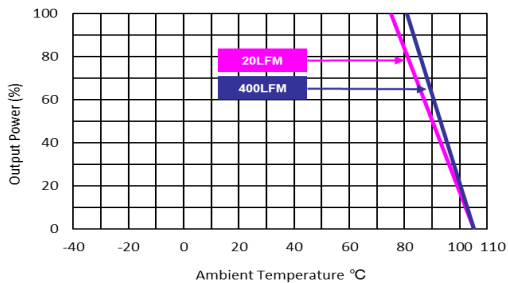

Derating Output Current Versus Ambient Temperature and Airflow
 $V_{in}=V_{in\ nom}$

Characteristic Curves

All test conditions are at 25°C The figures are identical for MCWI02-12D05

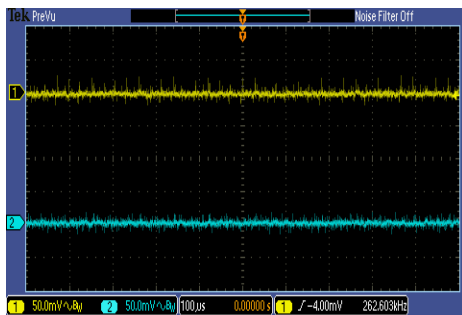
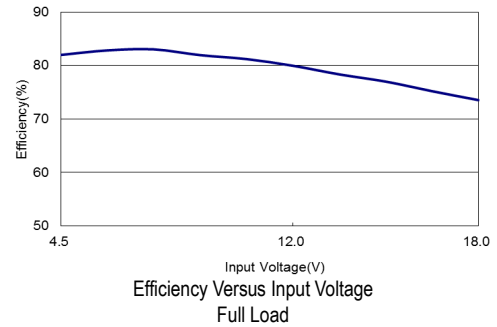
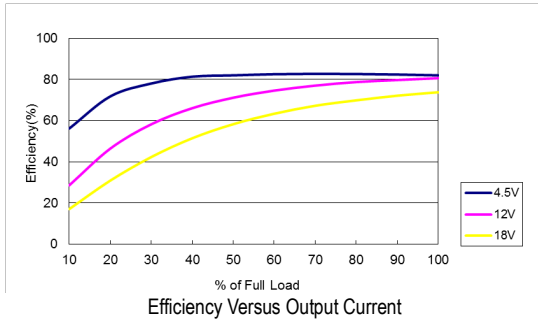

Typical Output Ripple and Noise
 $V_{in}=V_{in\ nom}$; Full Load

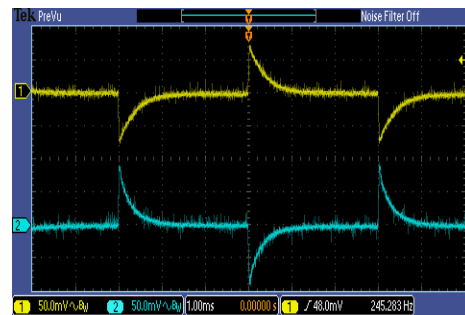

Transient Response to Dynamic Load Change
from 100% to 75% of Full Load ; $V_{in}=V_{in\ nom}$

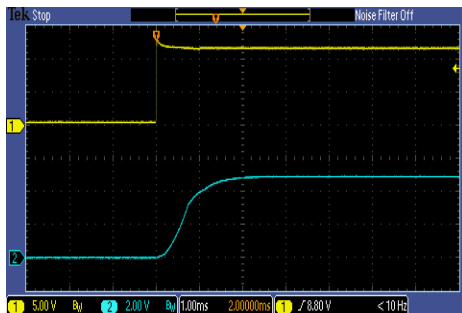

Typical Input Start-Up and Output Rise Characteristic
 $V_{in}=V_{in\ nom}$; Full Load

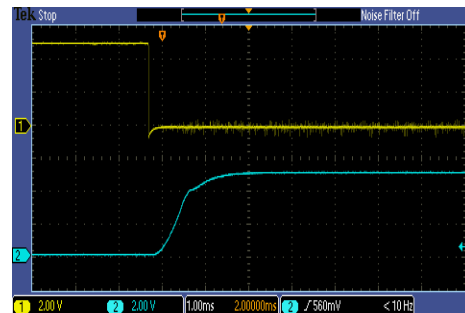

ON/OFF Voltage Start-Up and Output Rise Characteristic
 $V_{in}=V_{in\ nom}$; Full Load

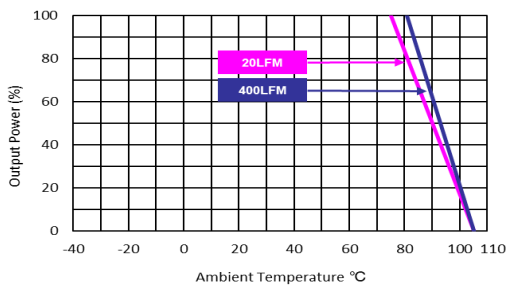

Derating Output Current Versus Ambient Temperature and Airflow
 $V_{in}=V_{in\ nom}$

Characteristic Curves

All test conditions are at 25°C The figures are identical for MCWI02-12D12

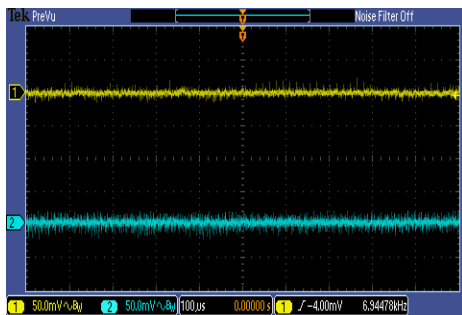
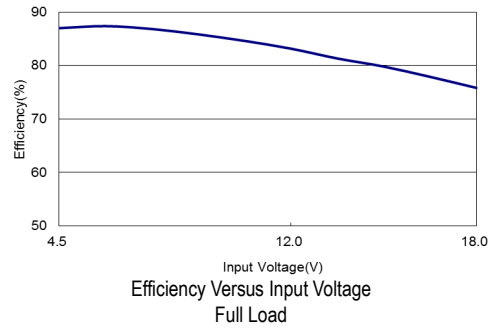
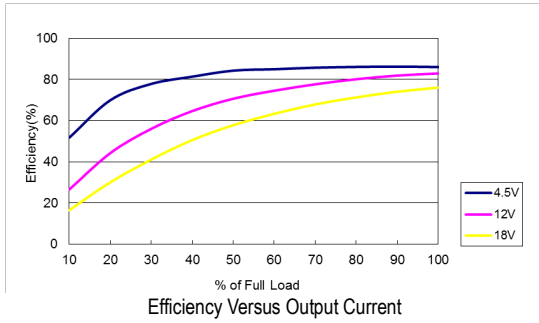

Typical Output Ripple and Noise
 $V_{in}=V_{in\ nom}$; Full Load

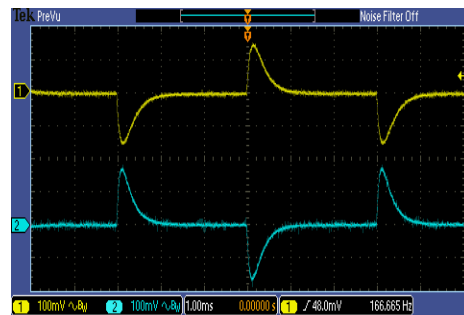

Transient Response to Dynamic Load Change
from 100% to 75% of Full Load; $V_{in}=V_{in\ nom}$

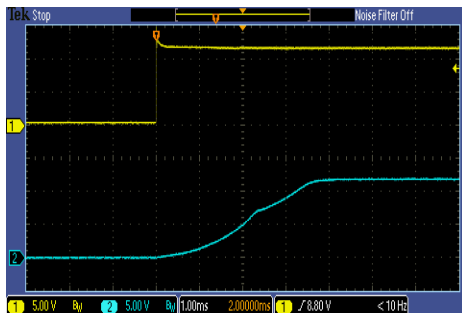

Typical Input Start-Up and Output Rise Characteristic
 $V_{in}=V_{in\ nom}$; Full Load

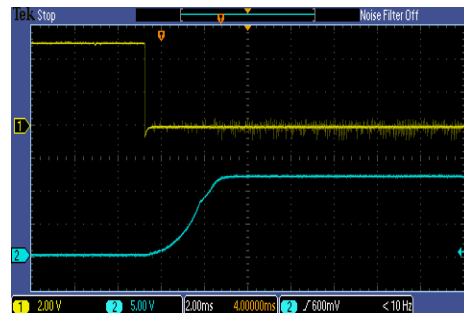

ON/OFF Voltage Start-Up and Output Rise Characteristic
 $V_{in}=V_{in\ nom}$; Full Load

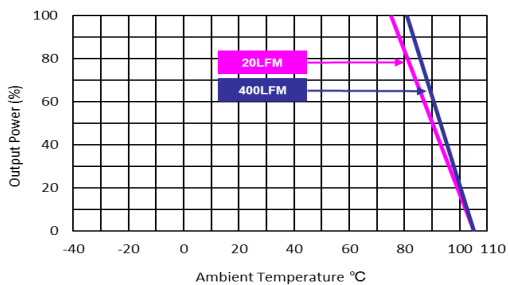

Derating Output Current Versus Ambient Temperature and Airflow
 $V_{in}=V_{in\ nom}$

Characteristic Curves

All test conditions are at 25°C The figures are identical for MCWI02-12D15

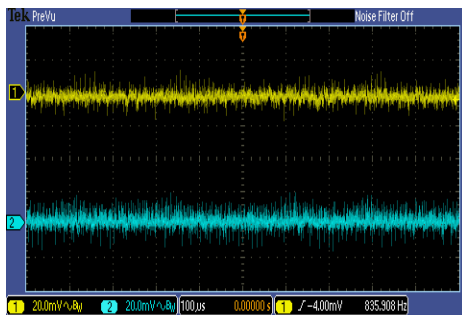
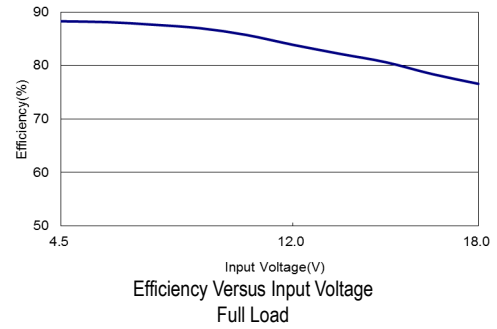
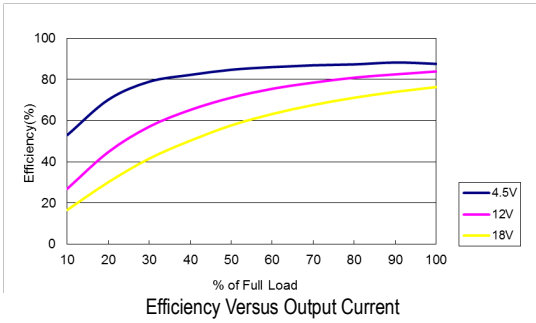

Typical Output Ripple and Noise
 $V_{in}=V_{in\ nom}$; Full Load

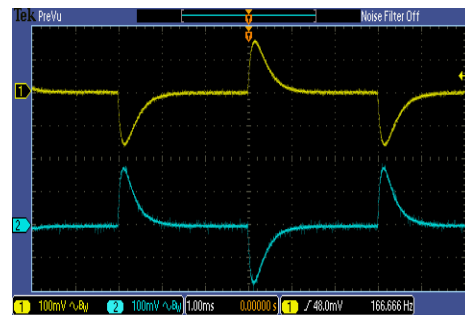

Transient Response to Dynamic Load Change
from 100% to 75% of Full Load; $V_{in}=V_{in\ nom}$

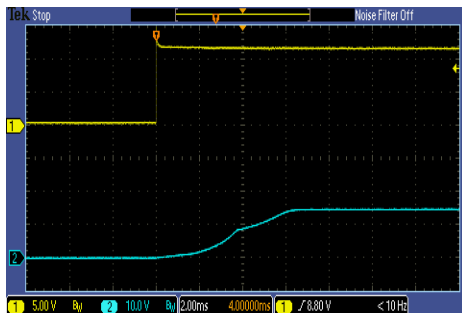

Typical Input Start-Up and Output Rise Characteristic
 $V_{in}=V_{in\ nom}$; Full Load

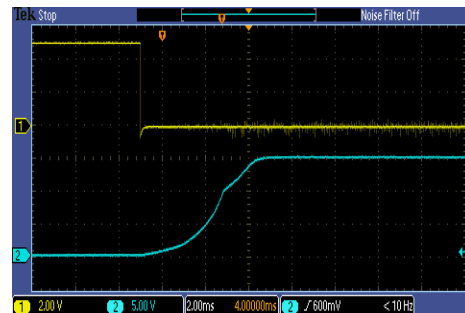

ON/OFF Voltage Start-Up and Output Rise Characteristic
 $V_{in}=V_{in\ nom}$; Full Load

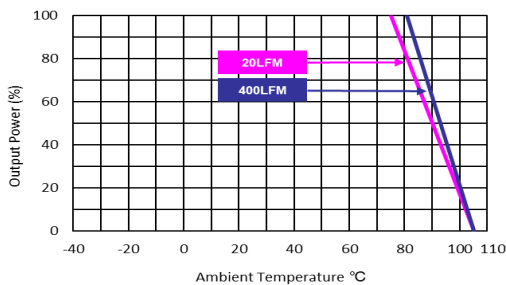

Derating Output Current Versus Ambient Temperature and Airflow
 $V_{in}=V_{in\ nom}$

Characteristic Curves

All test conditions are at 25°C The figures are identical for MCWI02-24S033

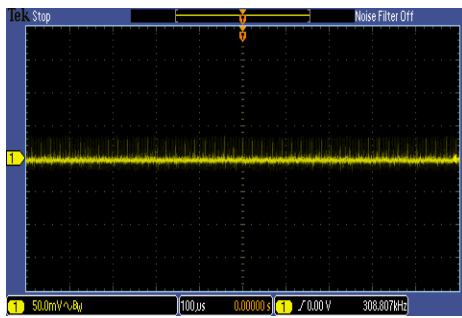
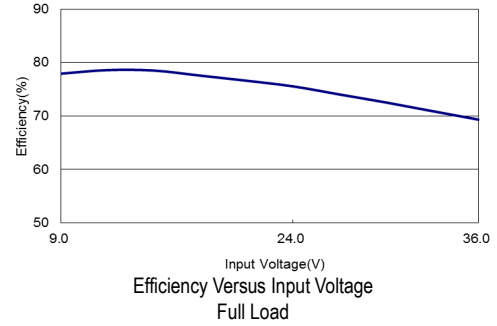
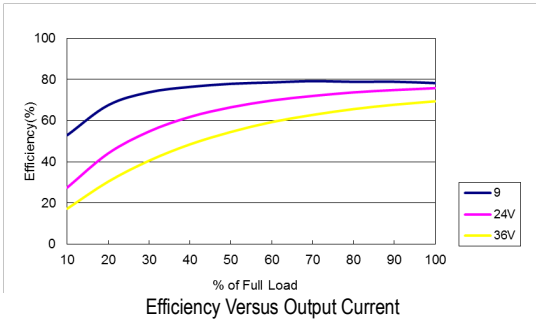

Typical Output Ripple and Noise
 $V_{in}=V_{in\ nom}$; Full Load

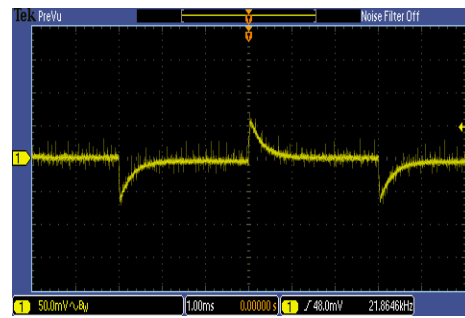

Transient Response to Dynamic Load Change
from 100% to 75% of Full Load ; $V_{in}=V_{in\ nom}$

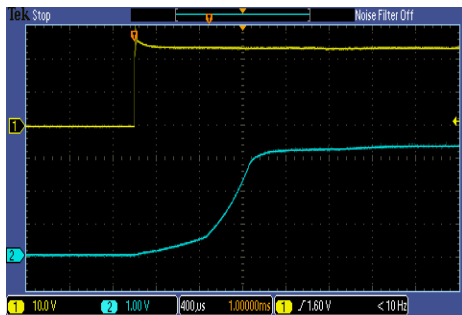

Typical Input Start-Up and Output Rise Characteristic
 $V_{in}=V_{in\ nom}$; Full Load

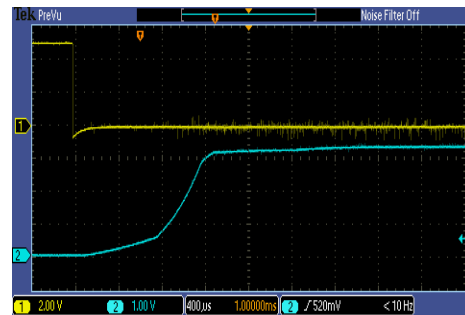

ON/OFF Voltage Start-Up and Output Rise Characteristic
 $V_{in}=V_{in\ nom}$; Full Load

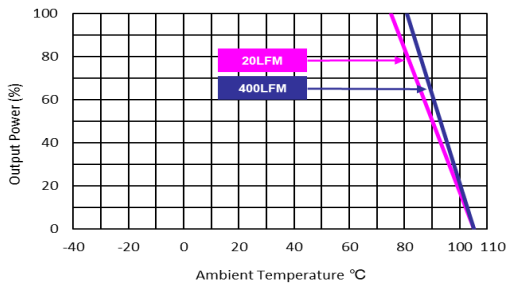

Derating Output Current Versus Ambient Temperature and Airflow
 $V_{in}=V_{in\ nom}$

Characteristic Curves

All test conditions are at 25°C The figures are identical for MCWI02-24S05

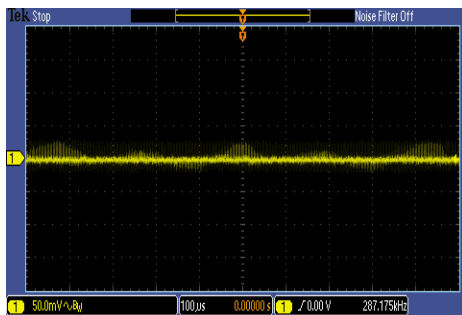
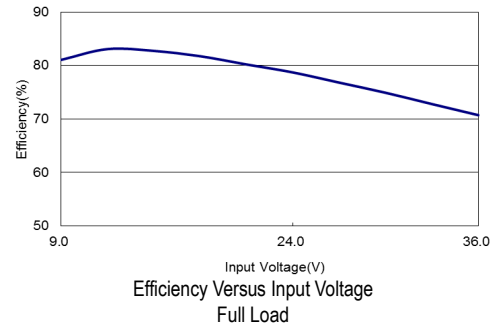
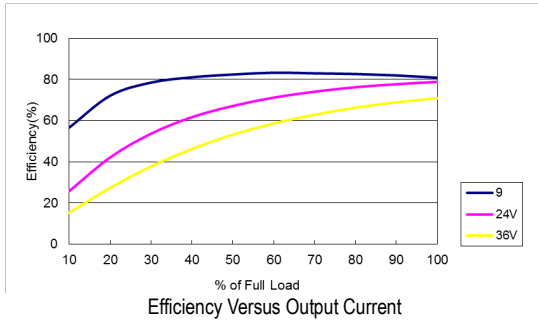

Typical Output Ripple and Noise
 $V_{in}=V_{in\ nom}$; Full Load

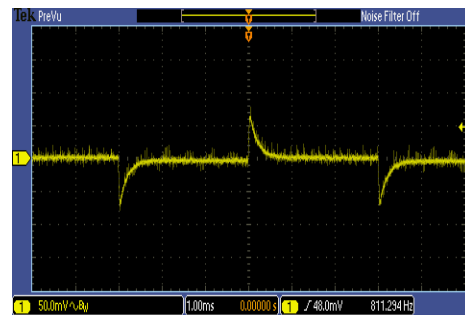

Transient Response to Dynamic Load Change
from 100% to 75% of Full Load ; $V_{in}=V_{in\ nom}$



Typical Input Start-Up and Output Rise Characteristic
 $V_{in}=V_{in\ nom}$; Full Load

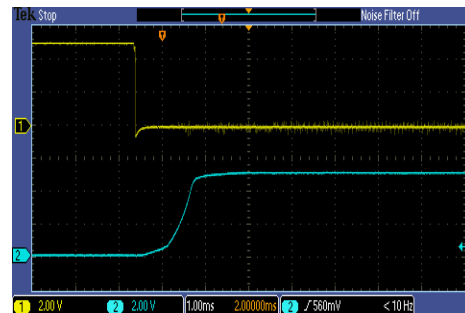

ON/OFF Voltage Start-Up and Output Rise Characteristic
 $V_{in}=V_{in\ nom}$; Full Load

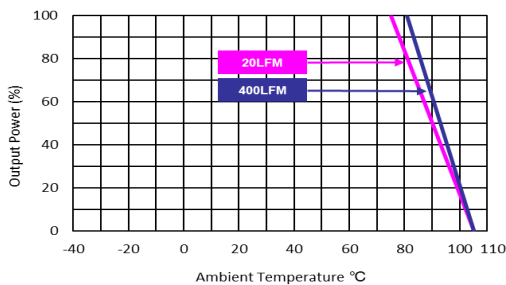

Derating Output Current Versus Ambient Temperature and Airflow
 $V_{in}=V_{in\ nom}$

Characteristic Curves

All test conditions are at 25°C The figures are identical for MCWI02-24S12

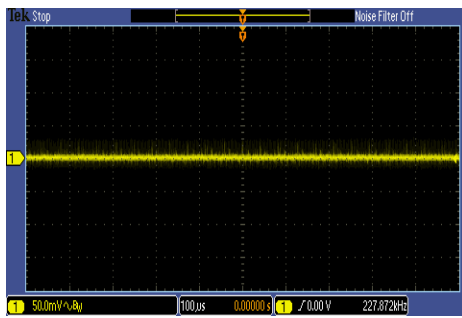
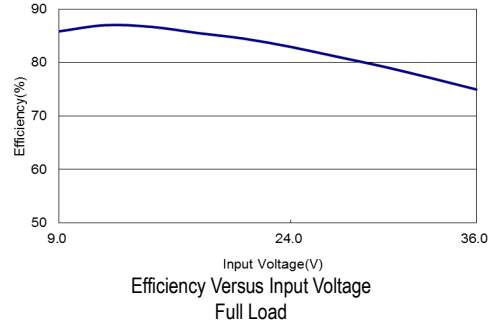
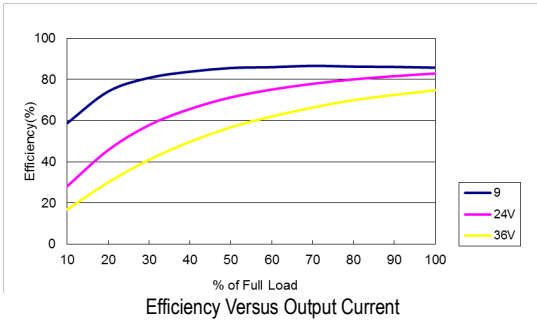

Typical Output Ripple and Noise
 $V_{in}=V_{in\ nom}$; Full Load

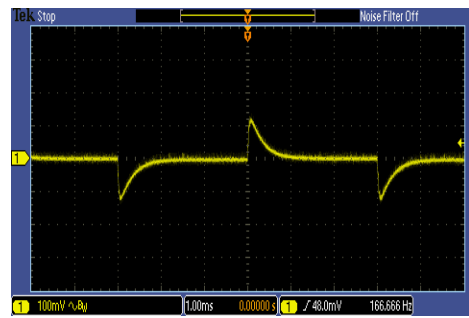

Transient Response to Dynamic Load Change
from 100% to 75% of Full Load ; $V_{in}=V_{in\ nom}$

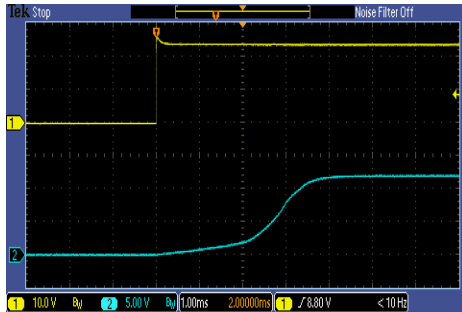

Typical Input Start-Up and Output Rise Characteristic
 $V_{in}=V_{in\ nom}$; Full Load

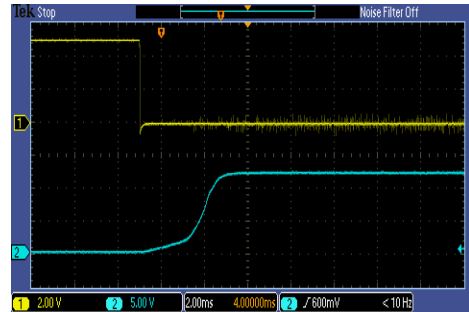

ON/OFF Voltage Start-Up and Output Rise Characteristic
 $V_{in}=V_{in\ nom}$; Full Load

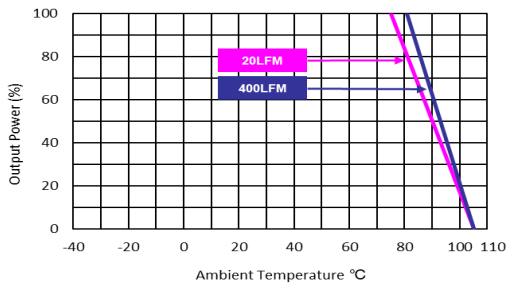

Derating Output Current Versus Ambient Temperature and Airflow
 $V_{in}=V_{in\ nom}$

Characteristic Curves

All test conditions are at 25°C The figures are identical for MCWI02-24S15

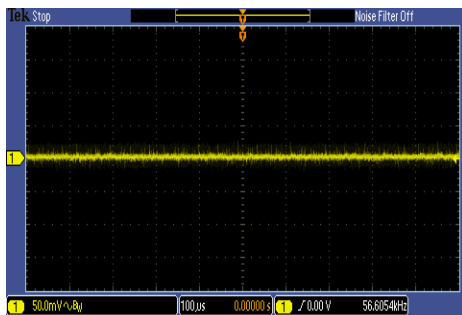
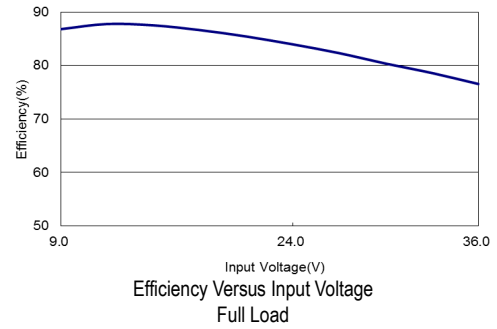
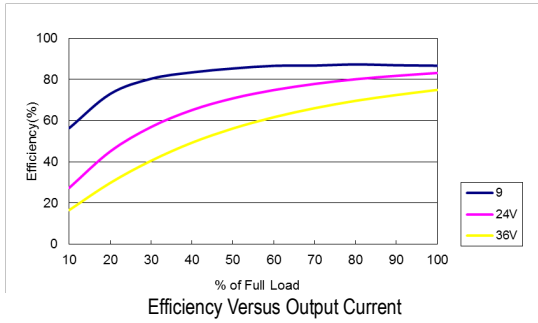

Typical Output Ripple and Noise
 $V_{in}=V_{in\ nom}$; Full Load

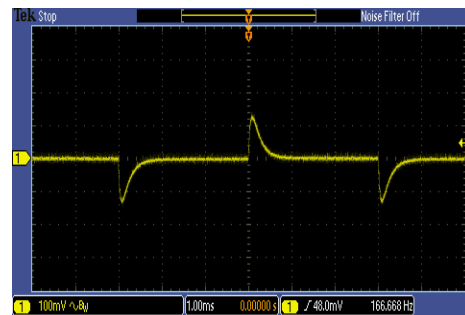

Transient Response to Dynamic Load Change
from 100% to 75% of Full Load ; $V_{in}=V_{in\ nom}$

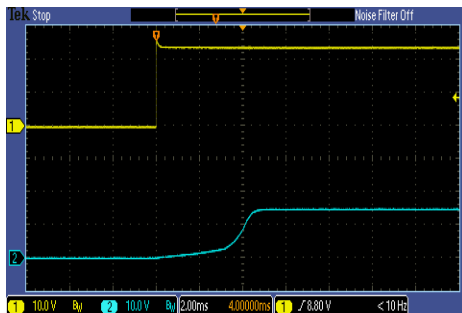

Typical Input Start-Up and Output Rise Characteristic
 $V_{in}=V_{in\ nom}$; Full Load

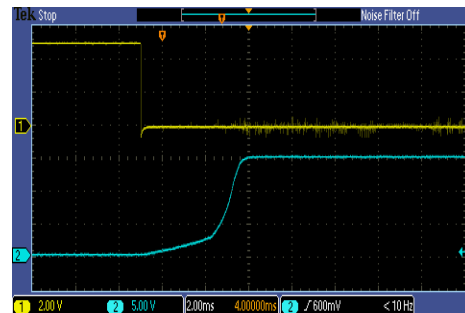

ON/OFF Voltage Start-Up and Output Rise Characteristic
 $V_{in}=V_{in\ nom}$; Full Load

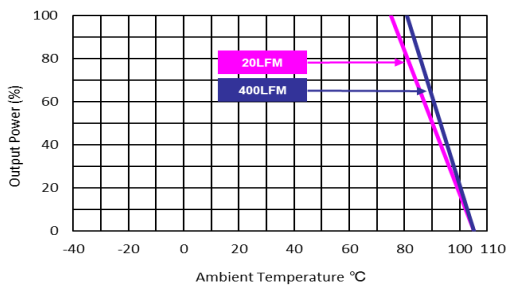

Derating Output Current Versus Ambient Temperature and Airflow
 $V_{in}=V_{in\ nom}$

Characteristic Curves

All test conditions are at 25°C The figures are identical for MCWI02-24D05

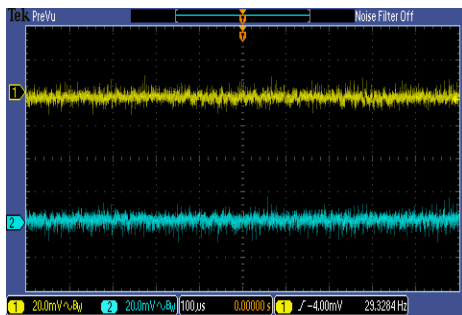
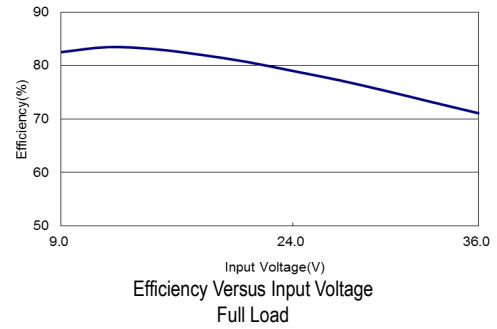
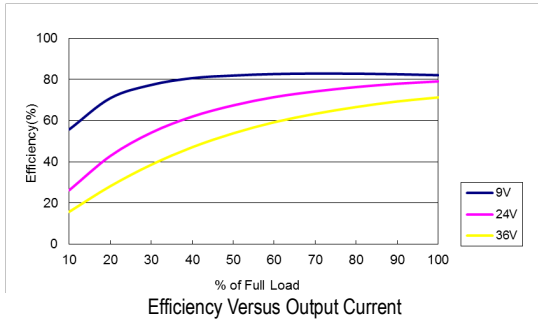

Typical Output Ripple and Noise
 $V_{in}=V_{in\ nom}$; Full Load

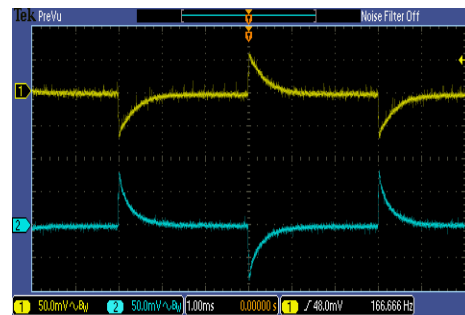

Transient Response to Dynamic Load Change
from 100% to 75% of Full Load ; $V_{in}=V_{in\ nom}$

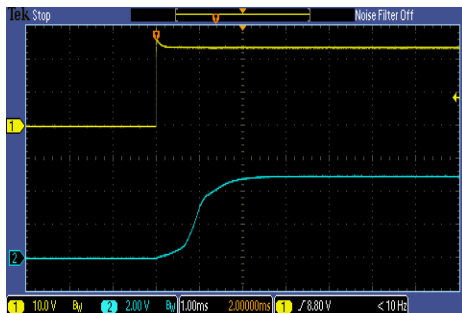

Typical Input Start-Up and Output Rise Characteristic
 $V_{in}=V_{in\ nom}$; Full Load

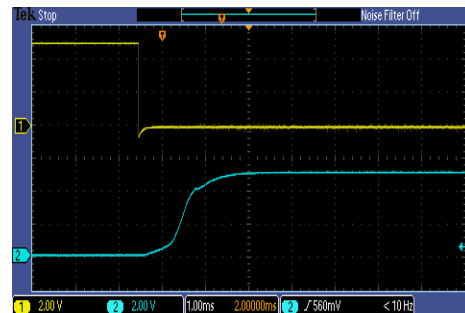

ON/OFF Voltage Start-Up and Output Rise Characteristic
 $V_{in}=V_{in\ nom}$; Full Load

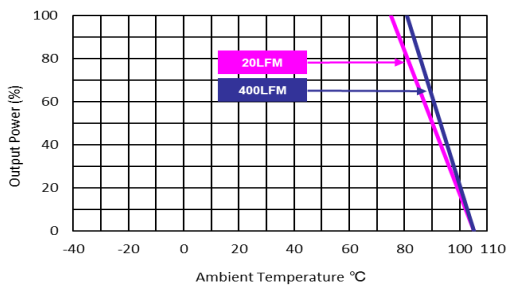

Derating Output Current Versus Ambient Temperature and Airflow
 $V_{in}=V_{in\ nom}$

Characteristic Curves

All test conditions are at 25°C The figures are identical for MCWI02-24D12

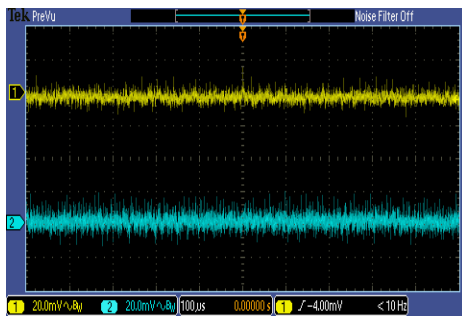
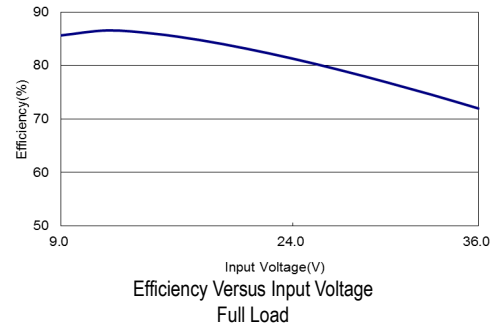
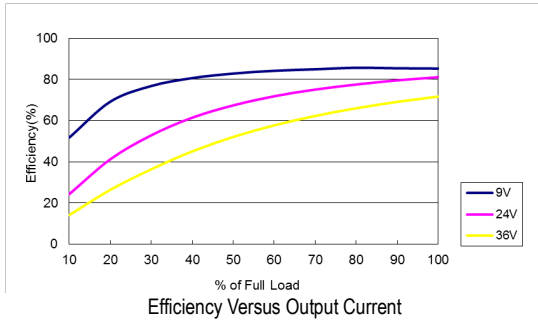

Typical Output Ripple and Noise
 $V_{in}=V_{in\ nom}$; Full Load

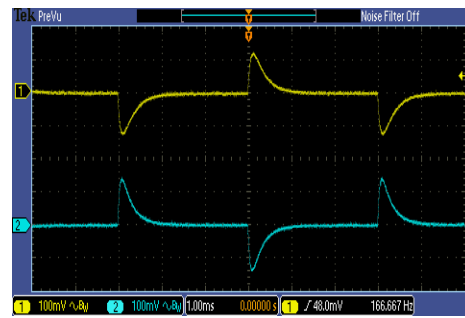

Transient Response to Dynamic Load Change
from 100% to 75% of Full Load; $V_{in}=V_{in\ nom}$

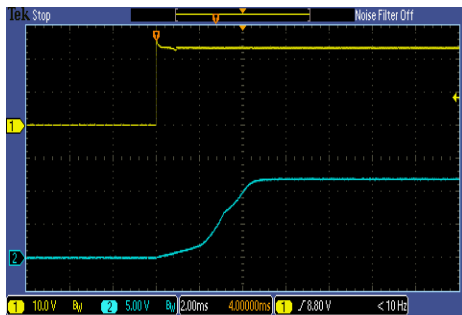

Typical Input Start-Up and Output Rise Characteristic
 $V_{in}=V_{in\ nom}$; Full Load



ON/OFF Voltage Start-Up and Output Rise Characteristic
 $V_{in}=V_{in\ nom}$; Full Load

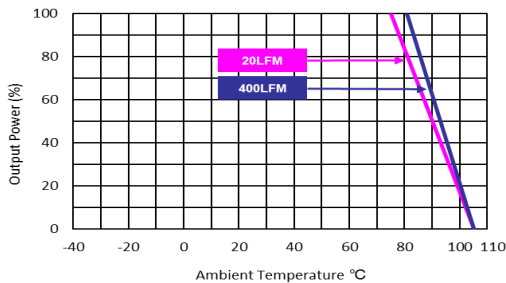

Derating Output Current Versus Ambient Temperature and Airflow
 $V_{in}=V_{in\ nom}$

Characteristic Curves

All test conditions are at 25°C The figures are identical for MCWI02-24D15

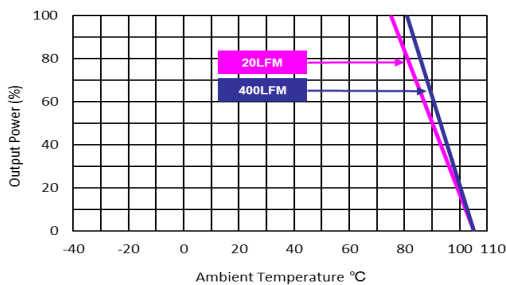
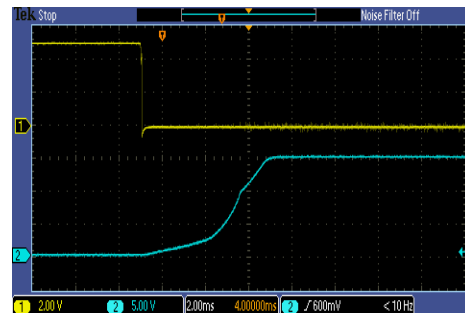
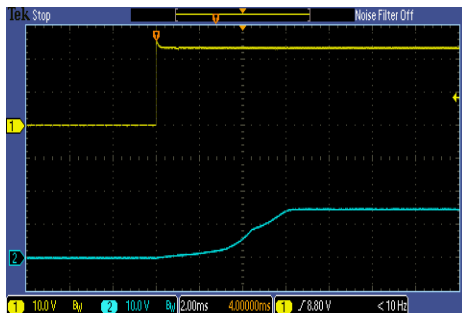
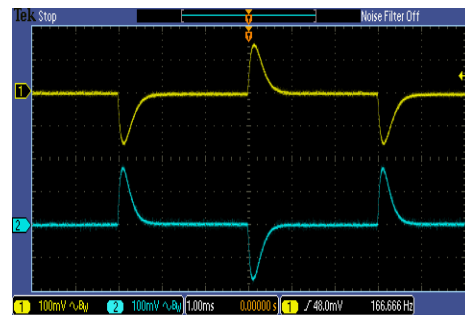
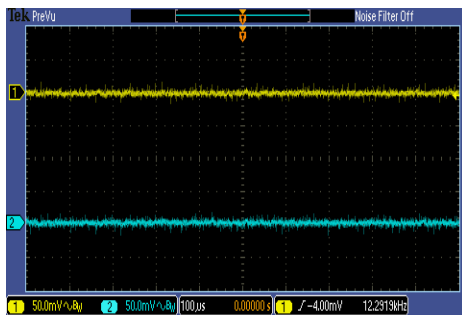
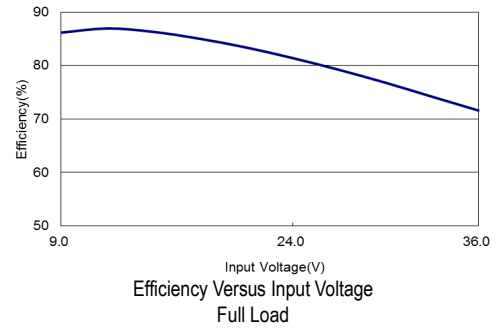
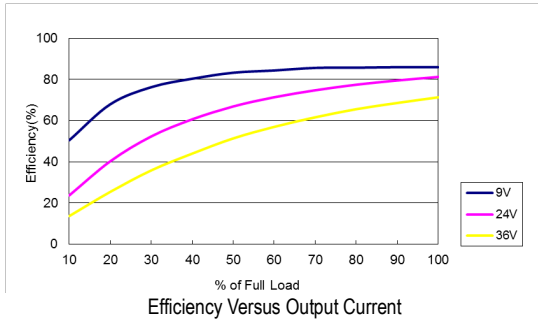

Characteristic Curves

All test conditions are at 25°C The figures are identical for MCWI02-48S033

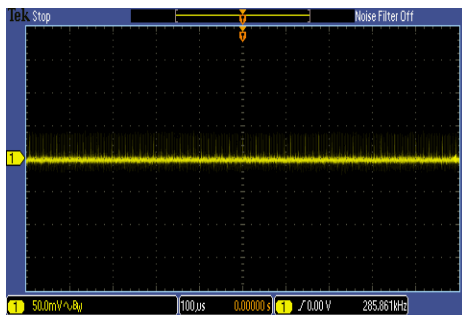
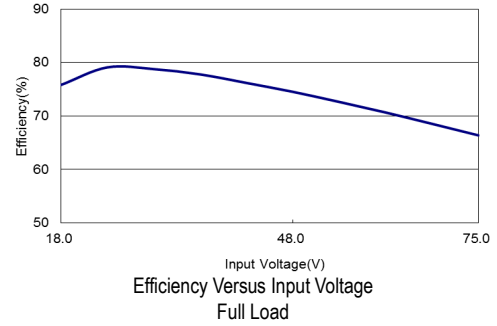
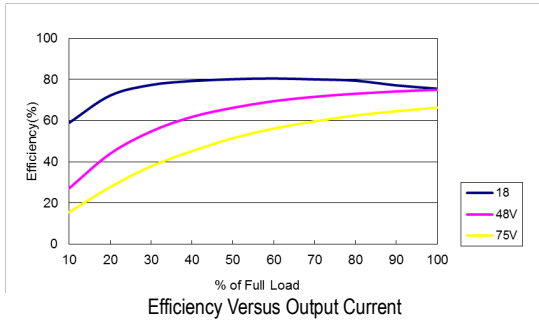

Typical Output Ripple and Noise
 $V_{in}=V_{in\ nom}$; Full Load

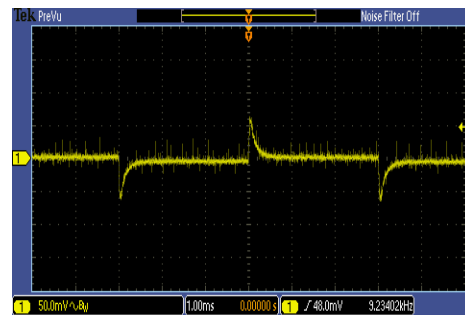

Transient Response to Dynamic Load Change
from 100% to 75% of Full Load ; $V_{in}=V_{in\ nom}$

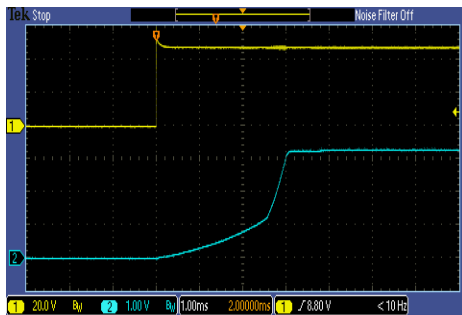

Typical Input Start-Up and Output Rise Characteristic
 $V_{in}=V_{in\ nom}$; Full Load

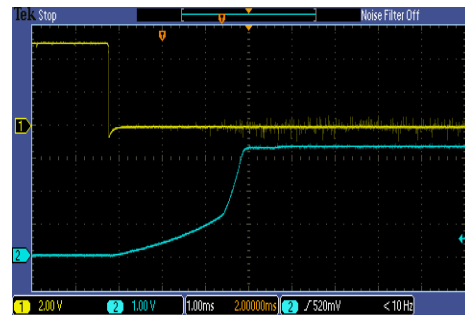

ON/OFF Voltage Start-Up and Output Rise Characteristic
 $V_{in}=V_{in\ nom}$; Full Load

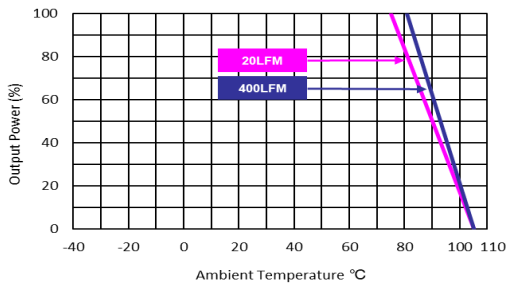

Derating Output Current Versus Ambient Temperature and Airflow
 $V_{in}=V_{in\ nom}$

Characteristic Curves

All test conditions are at 25°C The figures are identical for MCWI02-48S05

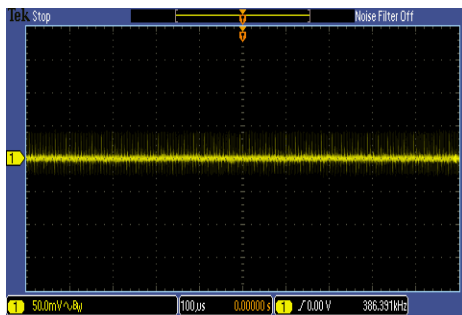
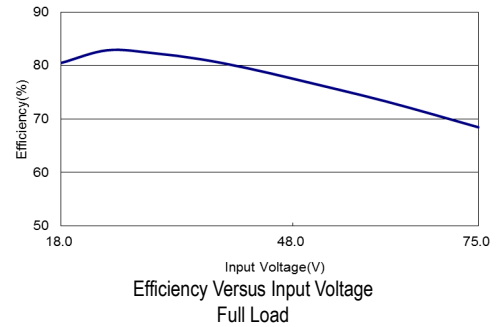
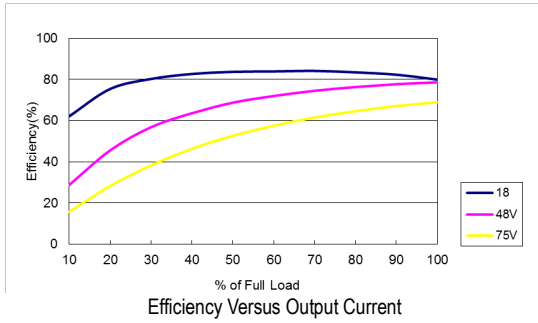

Typical Output Ripple and Noise
 $V_{in}=V_{in\ nom}$; Full Load

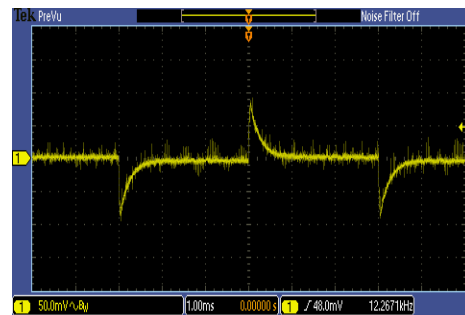

Transient Response to Dynamic Load Change
from 100% to 75% of Full Load ; $V_{in}=V_{in\ nom}$

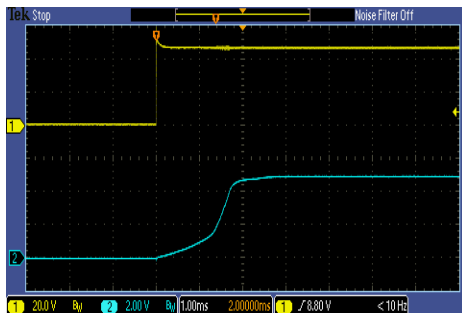

Typical Input Start-Up and Output Rise Characteristic
 $V_{in}=V_{in\ nom}$; Full Load

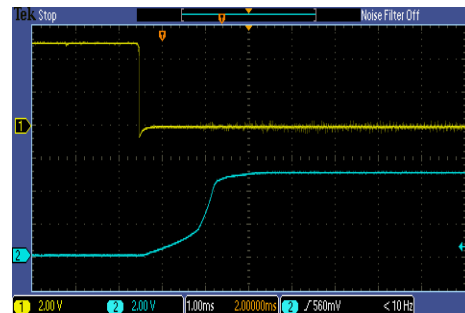

ON/OFF Voltage Start-Up and Output Rise Characteristic
 $V_{in}=V_{in\ nom}$; Full Load

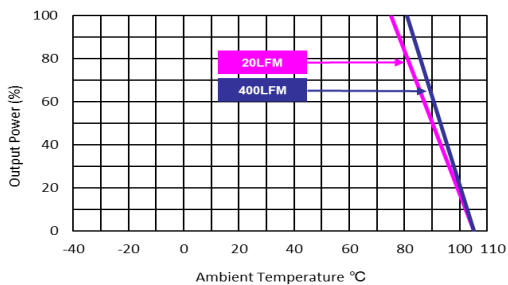

Derating Output Current Versus Ambient Temperature and Airflow
 $V_{in}=V_{in\ nom}$

Characteristic Curves

All test conditions are at 25°C The figures are identical for MCWI02-48S12

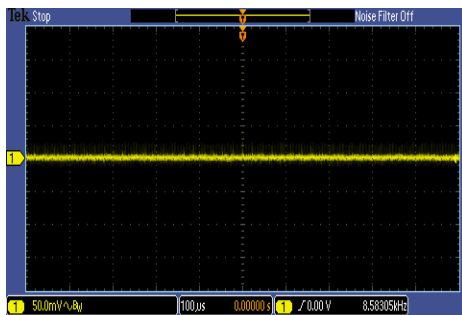
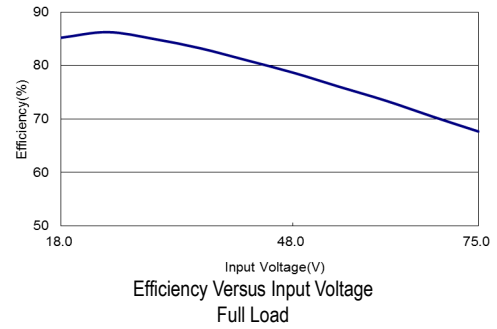
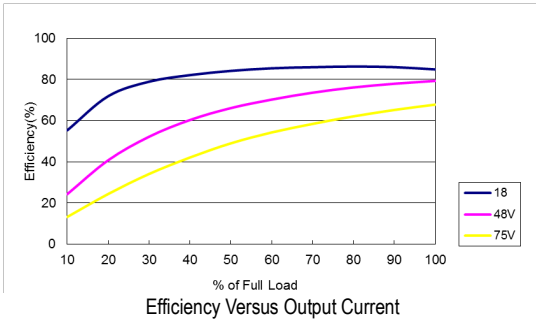

Typical Output Ripple and Noise
 $V_{in}=V_{in\ nom}$; Full Load

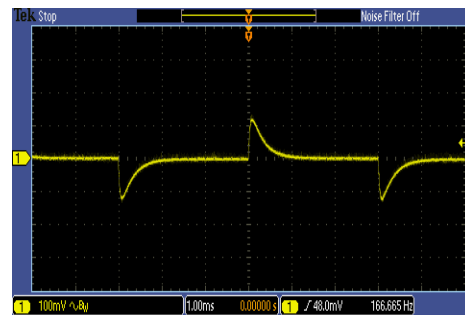

Transient Response to Dynamic Load Change
from 100% to 75% of Full Load ; $V_{in}=V_{in\ nom}$

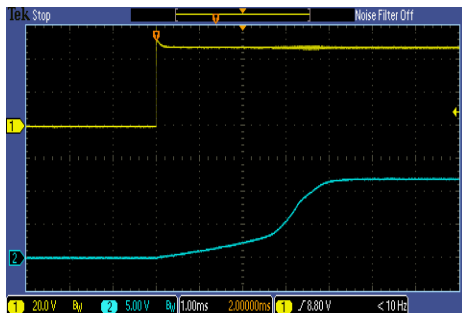

Typical Input Start-Up and Output Rise Characteristic
 $V_{in}=V_{in\ nom}$; Full Load

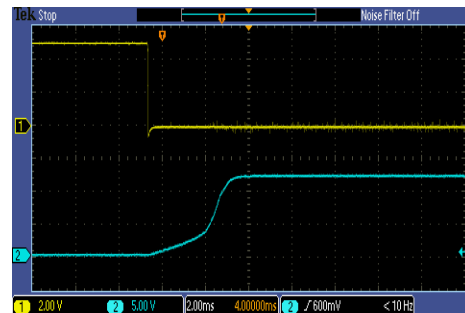

ON/OFF Voltage Start-Up and Output Rise Characteristic
 $V_{in}=V_{in\ nom}$; Full Load

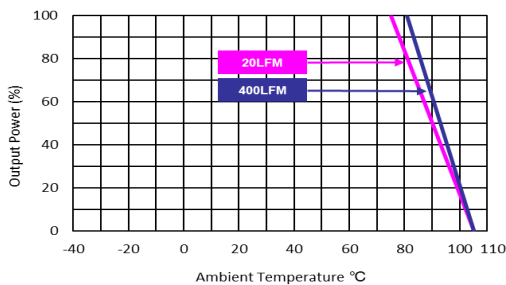

Derating Output Current Versus Ambient Temperature and Airflow
 $V_{in}=V_{in\ nom}$

Characteristic Curves

All test conditions are at 25°C The figures are identical for MCWI02-48S15

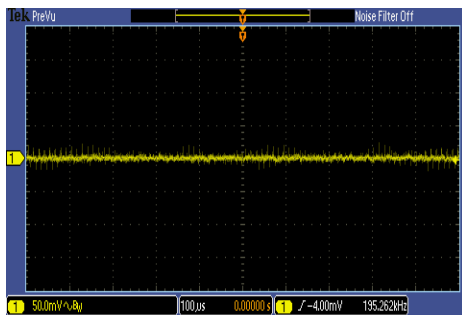
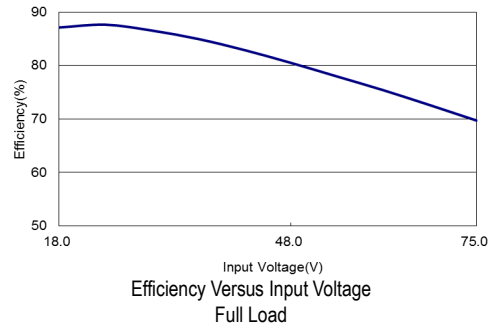
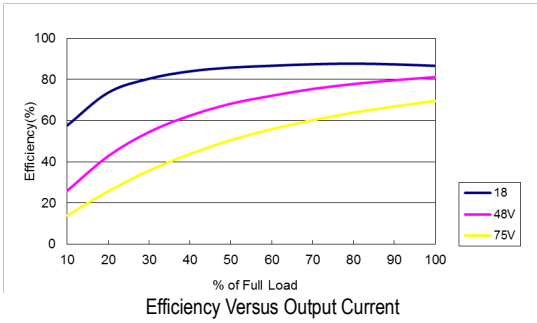

Typical Output Ripple and Noise
 $V_{in}=V_{in\ nom}$; Full Load



Transient Response to Dynamic Load Change
from 100% to 75% of Full Load ; $V_{in}=V_{in\ nom}$

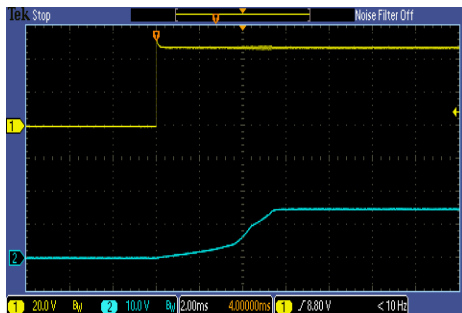

Typical Input Start-Up and Output Rise Characteristic
 $V_{in}=V_{in\ nom}$; Full Load

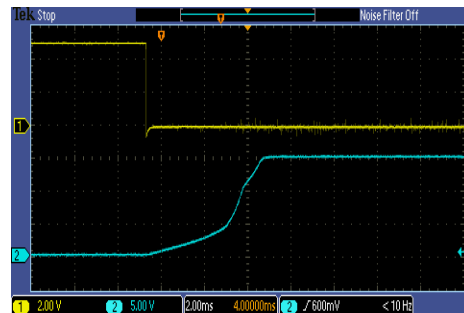

ON/OFF Voltage Start-Up and Output Rise Characteristic
 $V_{in}=V_{in\ nom}$; Full Load

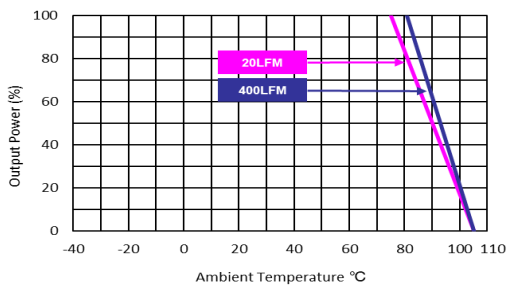

Derating Output Current Versus Ambient Temperature and Airflow
 $V_{in}=V_{in\ nom}$

Characteristic Curves

All test conditions are at 25°C The figures are identical for MCWI02-48D05

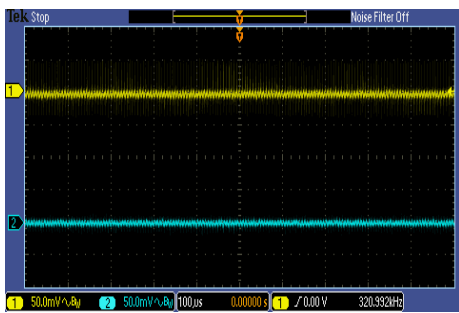
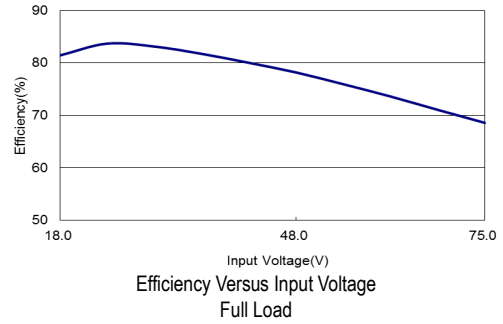
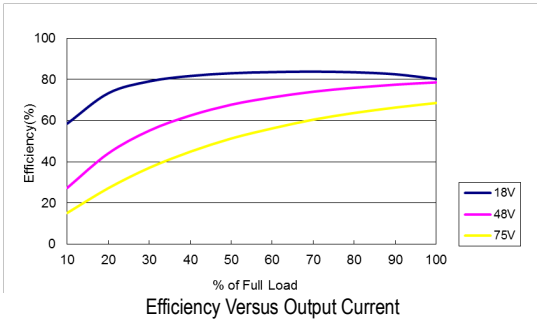

Typical Output Ripple and Noise
 $V_{in}=V_{in\ nom}$; Full Load

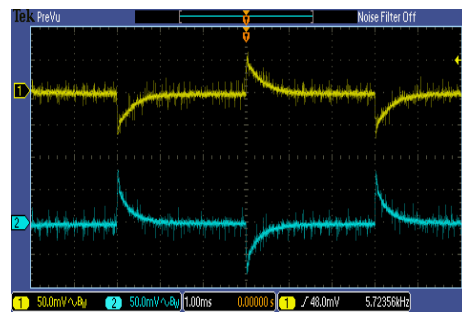

Transient Response to Dynamic Load Change
from 100% to 75% of Full Load ; $V_{in}=V_{in\ nom}$

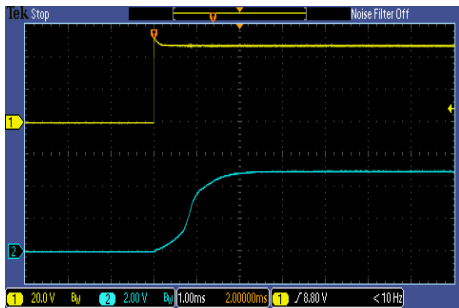

Typical Input Start-Up and Output Rise Characteristic
 $V_{in}=V_{in\ nom}$; Full Load

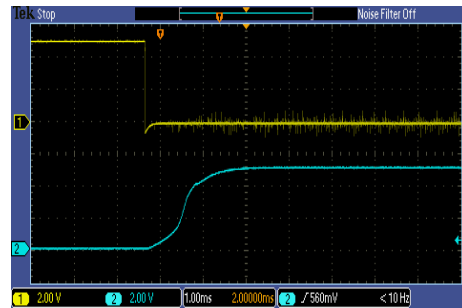

ON/OFF Voltage Start-Up and Output Rise Characteristic
 $V_{in}=V_{in\ nom}$; Full Load

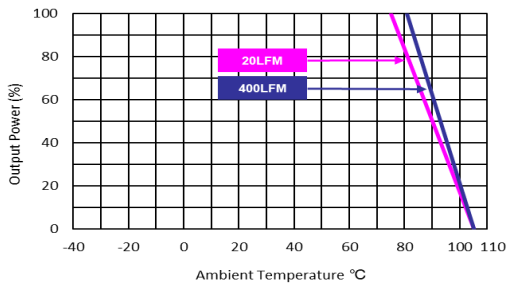

Derating Output Current Versus Ambient Temperature and Airflow
 $V_{in}=V_{in\ nom}$

Characteristic Curves

All test conditions are at 25°C The figures are identical for MCWI02-48D12

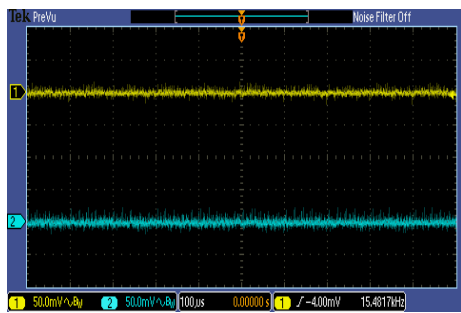
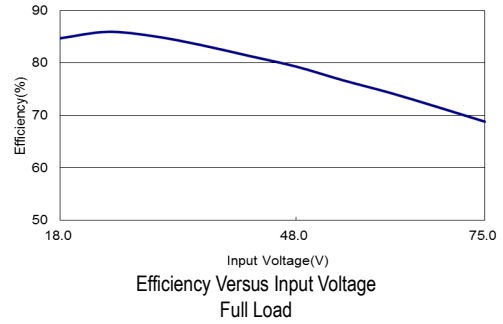
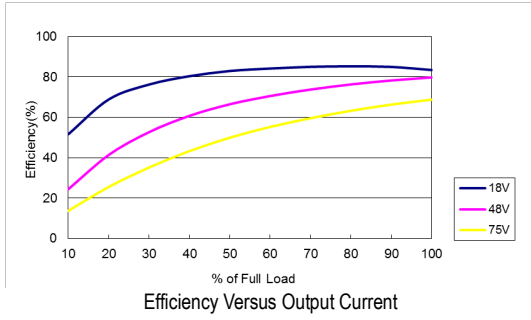

Typical Output Ripple and Noise
 $V_{in}=V_{in\ nom}$; Full Load

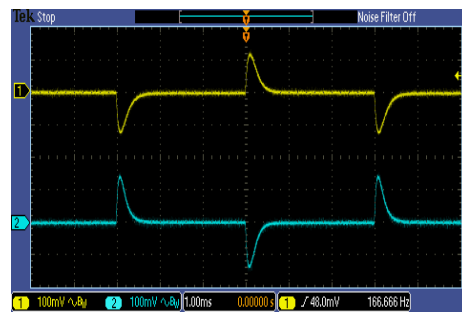

Transient Response to Dynamic Load Change
from 100% to 75% of Full Load; $V_{in}=V_{in\ nom}$

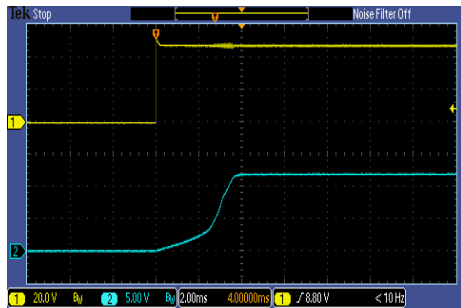

Typical Input Start-Up and Output Rise Characteristic
 $V_{in}=V_{in\ nom}$; Full Load

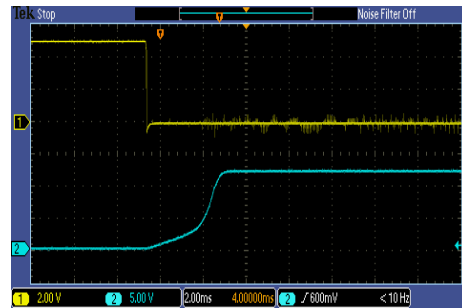

ON/OFF Voltage Start-Up and Output Rise Characteristic
 $V_{in}=V_{in\ nom}$; Full Load

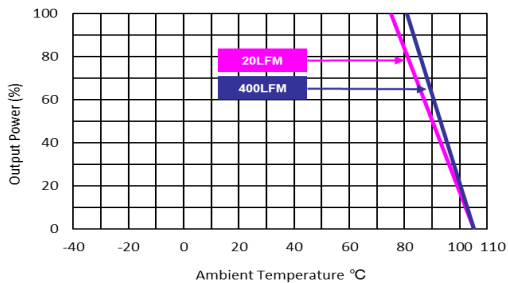

Derating Output Current Versus Ambient Temperature and Airflow
 $V_{in}=V_{in\ nom}$

Characteristic Curves

All test conditions are at 25°C The figures are identical for MCWI02-48D15

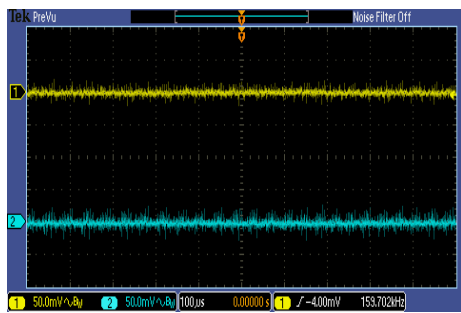
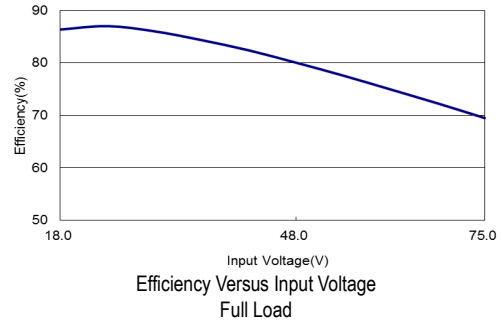
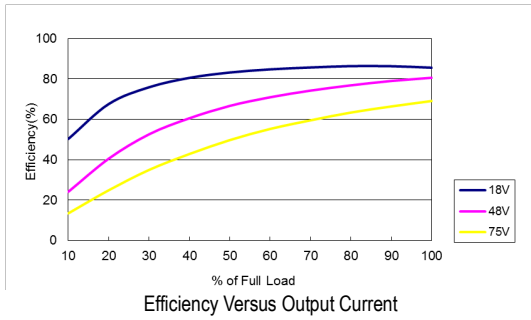

Typical Output Ripple and Noise
 $V_{in}=V_{in nom}$; Full Load

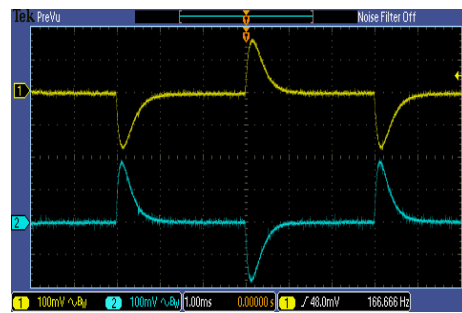

Transient Response to Dynamic Load Change
from 100% to 75% of Full Load; $V_{in}=V_{in nom}$

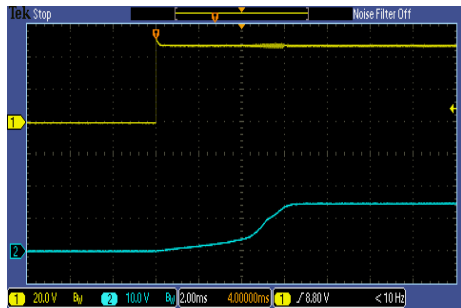

Typical Input Start-Up and Output Rise Characteristic
 $V_{in}=V_{in nom}$; Full Load

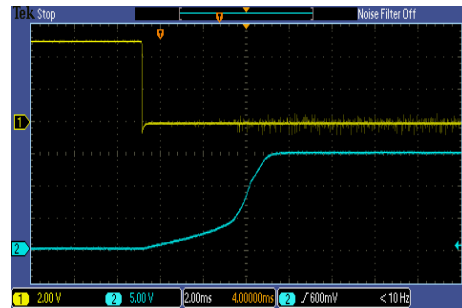

ON/OFF Voltage Start-Up and Output Rise Characteristic
 $V_{in}=V_{in nom}$; Full Load

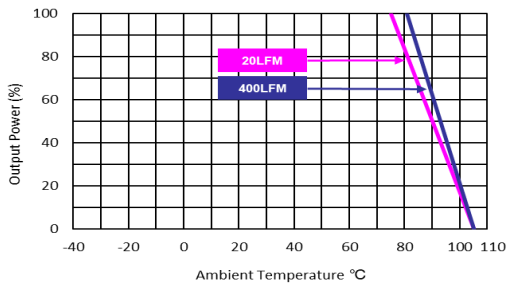

Derating Output Current Versus Ambient Temperature and Airflow
 $V_{in}=V_{in nom}$

Test Setup

Peak-to-Peak Output Noise Measurement Test

Use a Cout 0.47µF ceramic capacitor. Scope measurement should be made by using a BNC socket, measurement bandwidth is 0-20 MHz. Position the load between 50 mm and 75 mm from the DC-DC Converter.

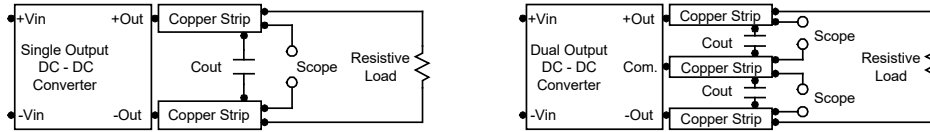

Technical Notes

Remote On/Off

Only one type of remote ON/OFF control is available for MCWI02. The module will turn on during the ON/OFF pin open or high impedance between ON/OFF pin and -Vin pin. The module will turn off if the ON/OFF pin is applied with a current of 2~4mA.

Maximum Capacitive Load

The MCWI02 series has limitation of maximum connected capacitance at the output. The power module may be operated in current limiting mode during start-up, affecting the ramp-up and the startup time. The maximum capacitance can be found in the data sheet.

Overcurrent Protection

To provide protection in a fault (output overload) condition, the unit is equipped with internal current limiting circuitry and can endure current limiting for an unlimited duration. At the point of current-limit inception, the unit shifts from voltage control to current control. The unit operates normally once the output current is brought back into its specified range.

Input Source Impedance

The power module should be connected to a low ac-impedance input source. Highly inductive source impedances can affect the stability of the power module.

In applications where power is supplied over long lines and output loading is high, it may be necessary to use a capacitor at the input to ensure startup.

Capacitor mounted close to the power module helps ensure stability of the unit, it is commended to use a good quality low Equivalent Series Resistance (ESR < 1.0Ω at 100 kHz) capacitor of a 4.7µF for the 12V input devices and a 2.2µF for the 24V and 48V devices.

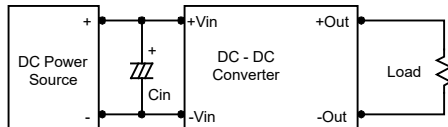

Output Ripple Reduction

A good quality low ESR capacitor placed as close as practicable across the load will give the best ripple and noise performance. To reduce output ripple, it is recommended to use 3.3µF capacitors at the output.

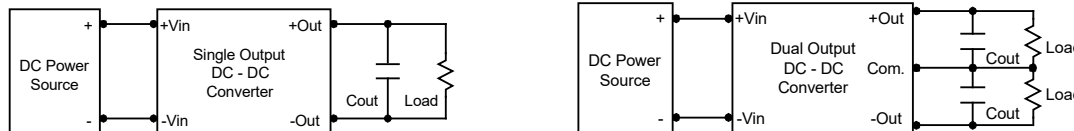

Thermal Considerations

Many conditions affect the thermal performance of the power module, such as orientation, airflow over the module and board spacing. To avoid exceeding the maximum temperature rating of the components inside the power module, the case temperature must be kept below 105°C. The derating curves are determined from measurements obtained in a test setup.

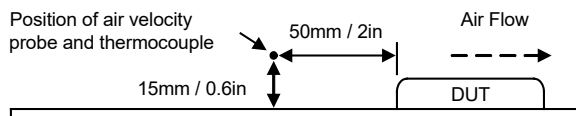

Remote On/Off Implementation

Only one type of remote ON/OFF control is available for MCWI02. The module will turn on during the ON/OFF pin open or high impedance between ON/OFF pin and -Vin pin. The module will turn off if the ON/OFF pin is applied with a current of 2~4mA.

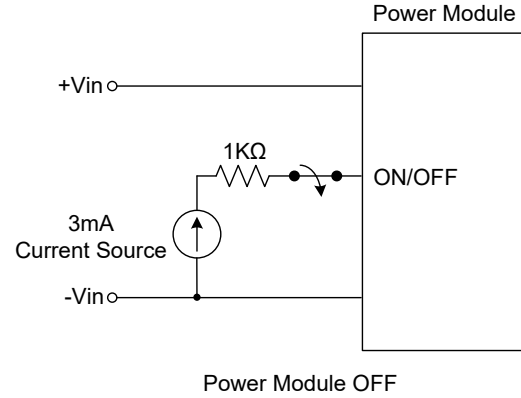
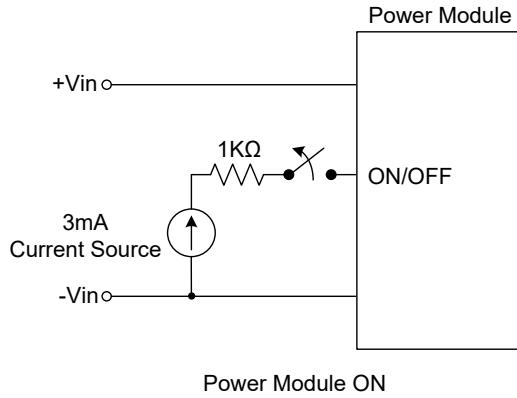

Packaging Information for Tube

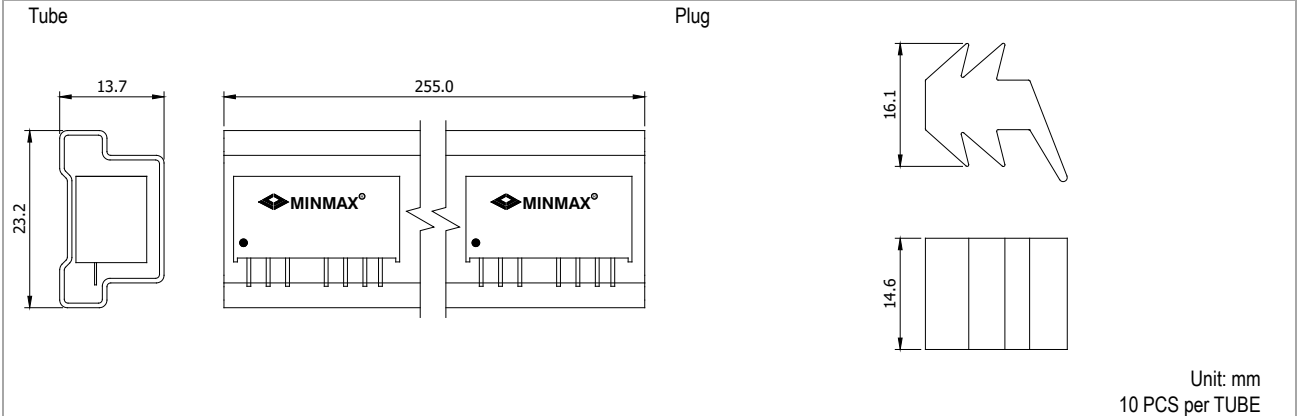

Wave Soldering Considerations

Lead free wave solder profile

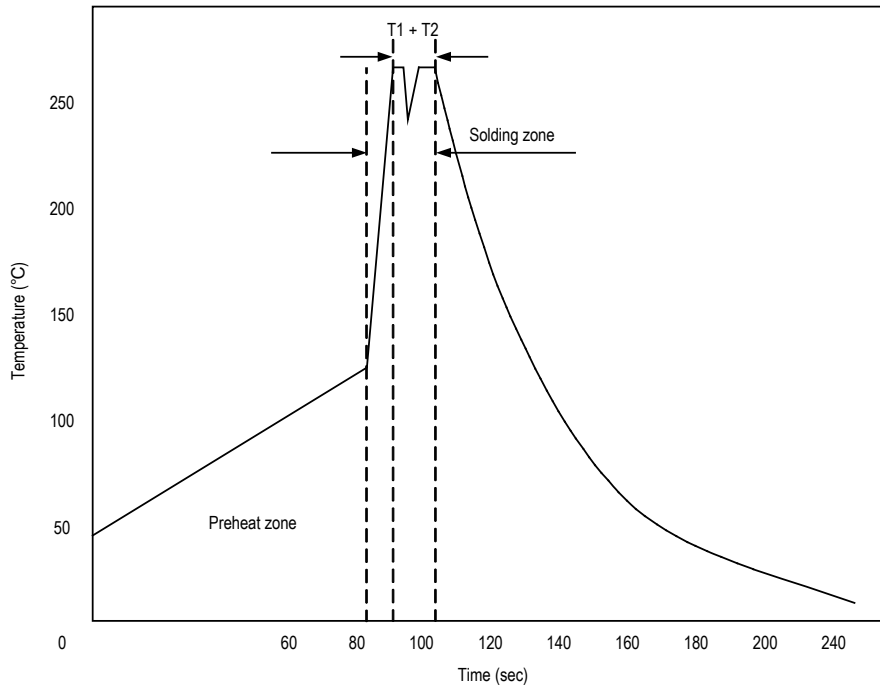

Zone	Reference Parameter
Preheat	Rise temp. speed : 3°C/sec max.
zone	Preheat temp. : 100~130°C
Actual	Peak temp. : 250~260°C
heating	Peak time(T1+T2) : 4~6 sec

Hand Welding Parameter

Reference Solder: Sn-Ag-Cu : Sn-Cu : Sn-Ag

Hand Welding: Soldering iron : Power 60W

Welding Time: 2~4 sec

Temp.: 380~400°C

Part Number Structure

M	C	WI	02	-	12	S	033
Package Type SIP-8	Ultra-wide 4:1 Input Voltage Range	Output Power 2 Watt	Input Voltage Range			Output Quantity	Output Voltage
			12: 4.5 ~ 18 VDC		S: Single	033: 3.3 VDC	
			24: 9 ~ 36 VDC		D: Dual	05: 5 VDC	
			48: 18 ~ 75 VDC			12: 12 VDC	
						15: 15 VDC	

MTBF and Reliability

The MTBF of MCWI02 series of DC-DC converters has been calculated using

MIL-HDBK 217F NOTICE2, Operating Temperature 25°C, Ground Benign.

Model	MTBF	Unit
MCWI02-12S033	5,490,000	Hours
MCWI02-12S05	4,950,000	
MCWI02-12S12	5,860,000	
MCWI02-12S15	5,350,000	
MCWI02-12D05	3,990,000	
MCWI02-12D12	4,200,000	
MCWI02-12D15	3,430,000	
MCWI02-24S033	5,570,000	
MCWI02-24S05	5,060,000	
MCWI02-24S12	5,940,000	
MCWI02-24S15	5,410,000	
MCWI02-24D05	4,030,000	
MCWI02-24D12	4,240,000	
MCWI02-24D15	3,460,000	
MCWI02-48S033	5,390,000	
MCWI02-48S05	5,010,000	
MCWI02-48S12	5,940,000	
MCWI02-48S15	5,410,000	
MCWI02-48D05	4,030,000	
MCWI02-48D12	4,240,000	
MCWI02-48D15	3,460,000	