



MINMAX[®]

ACF-10 Series

Electric Characteristic Note

ACF-10 Series EC Note

AC-DC Power Module 10W

Features

- ▶ Ultra Compact Size 1.5 x 1.0 x 0.6"
- ▶ Fully Encapsulated Module for PCB Mounting
- ▶ Universal Input 85-264VAC, 47-440Hz
- ▶ I/O Isolation 4000VAC with Reinforced Insulation
- ▶ No Min. Load Requirement
- ▶ Operating Ambient Temp. Range -25°C to +70°C
- ▶ Overload/Voltage and Short Circuit Protection
- ▶ EMI Emission EN 55032/14-1 Class B Approved
- ▶ EMC Immunity EN 61000-4-2,3,4,5,6,8,11 Approved
- ▶ Eco Design, Low No Load Power Consumption < 150mW
- ▶ Safety Approval to UL/cUL/IEC/EN 62368-1(60950-1), TUV IEC/EN 60335-1 & CE Marking



Applications

- ▶ Distributed power architectures
- ▶ Workstations
- ▶ Computer equipment
- ▶ Communications equipment

Product Overview

The ACF-10 Series is a range of ultra-small, fully encapsulated 10 Watt AC-DC power supply modules. They are designed for easy PCB mounting featuring measuring only 1.5"x1"x0.6". The ACF-10 series consist 7 models featuring universal AC input (85-264VAC) and fixed regulated single output voltage ranging from 3.3-48VDC; 4000VAC isolation with reinforced insulation; EMI emission EN 55032/14-1 Class B approved; EMC immunity EN 61000-4-2,3,4,5,6,8,11 approved; no minimum load requirement; short circuit / overload / overvoltage protection and low stand-by power consumption.

Table of contents

Model Selection Guide	P2	Package Specifications	P11
Input Specifications.....	P2	Recommended Pad Layout.....	P11
Output Specifications.....	P2	Packaging Information.....	P12
General Specifications.....	P2	Wave Soldering Considerations.....	P13
EMC Specifications.....	P3	Hand Welding Parameter	P13
Environmental Specifications	P3	Part Number Structure	P14
Characteristic Curves	P4	MTBF and Reliability	P14

Model Selection Guide							
Model Number	Output Voltage	Output Current		Input Current		Max. capacitive Load	Efficiency (typ.)
				115VAC, 60Hz	230VAC, 50Hz		
		Max.	Peak ⁽¹⁾	@Max. Load			@Max. Load, 115VAC
	VDC	mA	mA	mA(typ.)		μF	%
ACF-10S03	3.3	2600	3380	186	121	4400	77
ACF-10S05	5	2000	2600	209	136	2200	80
ACF-10S09	9	1100	1440	199	130	680	83
ACF-10S12	12	830	1080	198	129	390	84
ACF-10S15	15	660	860	197	128	240	84
ACF-10S24	24	410	530	191	124	100	86
ACF-10S48	48	210	270	201	130	24	84

Input Specifications						
Parameter	Conditions / Model	Min.	Typ.	Max.	Unit	
Input Voltage Range	All Models	85	---	264	VAC	
Input Frequency Range		47	---	440	Hz	
Input Voltage Range		120	---	370	VDC	
No-Load Power Consumption		---	---	0.15	W	
Inrush Current (Cold Start at 25°C)	115VAC	---	---	20	A	
	230VAC	---	---	40	A	

Output Specifications						
Parameter	Conditions / Model	Min.	Typ.	Max.	Unit	
Output Voltage Setting Accuracy		---	±1.0	±2.0	%	
Line Regulation	Vin=Min. to Max. @Full Load	---	---	±0.5	%	
Load Regulation	Io=0% to 100%	---	---	±1.0	%	
Minimum Load	No minimum Load Requirement					
Ripple & Noise	0-20 MHz Bandwidth	3.3V & 5VDC Output Models	---	---	60	mV _{P-P}
		Other Output Models	---	---	1	%V _{PP} of Vo
Over Voltage Protection	Zener diode clamp	---	125	---	% of Vo	
Temperature Coefficient		---	±0.01	±0.02	%°C	
Over Load Protection	Hiccup mode, auto-recovery (long term overload condition may cause damage)	---	150	---	%Inom.	
Short Circuit Protection	Hiccup mode, Automatic Recovery					

General Specifications						
Parameter	Conditions	Min.	Typ.	Max.	Unit	
I/O Isolation Voltage	60 Seconds	4000	---	---	VAC	
I/O Isolation Resistance	500 VDC	1000	---	---	MΩ	
Switching Frequency		---	45	---	kHz	
Hold-up Time	115VAC, 60Hz	---	8	---	ms	
	230VAC, 50Hz	---	40	---	ms	
MTBF (calculated)	MIL-HDBK-217F@25°C, Ground Benign	452,916	---	---	Hours	
Safety Approvals	UL/cUL 60950-1 recognition(UL certificate), IEC/EN 60950-1(CB-report)					
	UL/cUL 62368-1 recognition(UL certificate), IEC/EN 62368-1(CB-report)					
	IEC/EN 60335-1 recognition(TUV certificate,CB-report)					

EMC Specifications				
Parameter	Standards & Level			Performance
EMI	Conduction	EN 55014-1, EN 55032	Without external components	Class B
	Radiation			
EMS	EN 55014-2, EN 55035			
	ESD	EN 61000-4-2 Air \pm 8kV , Contact \pm 6kV		A
	Radiated immunity	EN 61000-4-3 10V/m		A
	Fast transient	EN 61000-4-4 \pm 2kV		A
	Surge	EN 61000-4-5 \pm 1kV		A
	Conducted immunity	EN 61000-4-6 10Vrms		A
	PFMF	EN 61000-4-8 30A/m		A
	Dips	EN 61000-4-11 30% 10ms		A
	Interruptions	EN 61000-4-11 >95% 5000ms		B

Environmental Specifications				
Parameter	Conditions	Min.	Max.	Unit
Operating Ambient Temperature Range		-25	+70	°C
Power Derating	+50°C to +70°C	0.25		W / °C
Storage Temperature Range		-40	+85	°C
Humidity (non condensing)		---	95	% rel. H
Lead Temperature (1.5mm from case for 10Sec.)		---	260	°C

Notes	
1	Peak load lasting <30s with a maximum duty cycle of 10%, average output power not to exceed maximum power.
2	All specifications typical at Ta=+25°C, resistive load, 115VAC, 60Hz input voltage and after warm-up time rated output current unless otherwise noted.
3	We recommend to protect the converter by a slow blow fuse in the input supply line.
4	Other input and output voltage may be available, please contact MINMAX.
5	Specifications are subject to change without notice.

Characteristic Curves

All test conditions are at 25°C The figures are identical for ACF-10S03

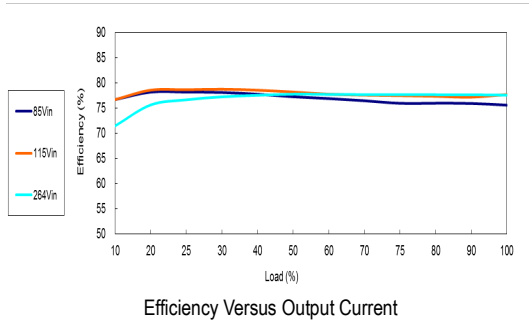

Efficiency Versus Output Current

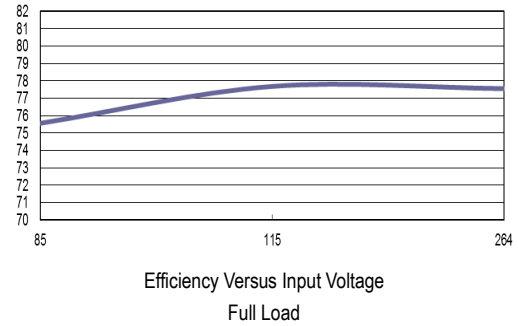

Efficiency Versus Input Voltage Full Load

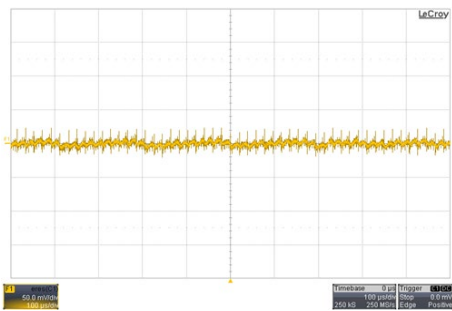

Typical Output Ripple and Noise
 $V_{in}=V_{in\ nom}$; Full Load

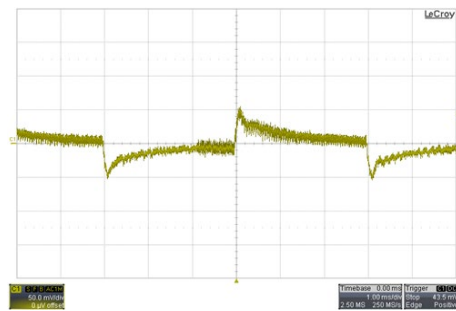

Transient Response to Dynamic Load Change
from 100% to 75% of Full Load ; $V_{in}=V_{in\ nom}$

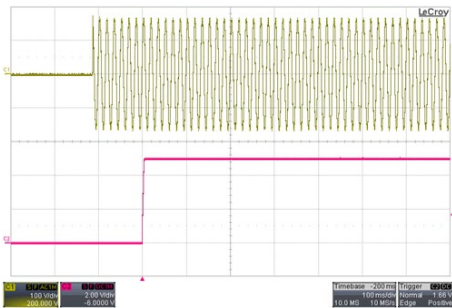

Typical Input Start-Up and Output Rise Characteristic
 $V_{in}=V_{in\ nom}$; Full Load

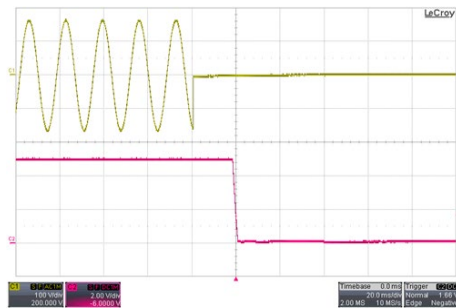

Typical Input Hold-up and Output Rise Characteristic
 $V_{in}=V_{in\ nom}$; Full Load

Characteristic Curves

All test conditions are at 25°C The figures are identical for ACF-10S05

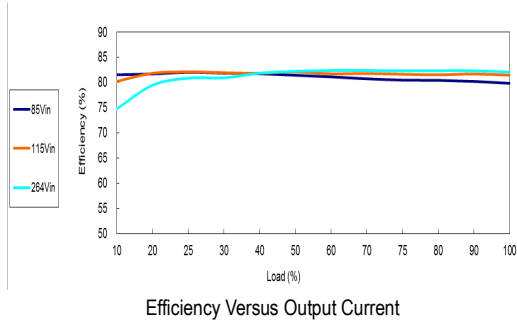

Efficiency Versus Output Current

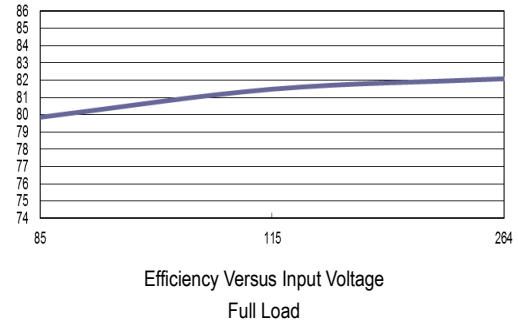

Efficiency Versus Input Voltage Full Load

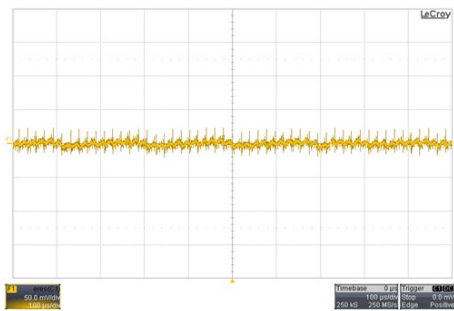

Typical Output Ripple and Noise
 $V_{in}=V_{in\ nom}$; Full Load

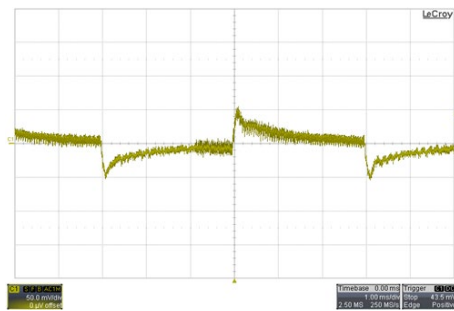

Transient Response to Dynamic Load Change
from 100% to 75% of Full Load ; $V_{in}=V_{in\ nom}$

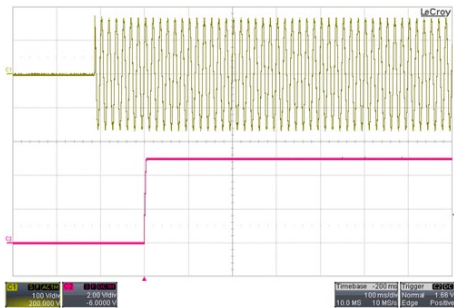

Typical Input Start-Up and Output Rise Characteristic
 $V_{in}=V_{in\ nom}$; Full Load

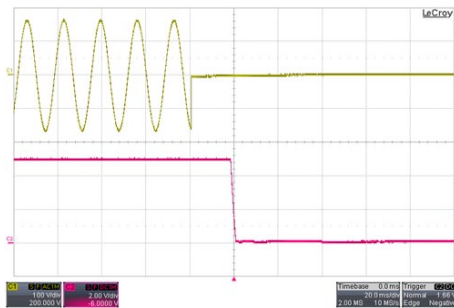

Typical Input Hold-up and Output Rise Characteristic
 $V_{in}=V_{in\ nom}$; Full Load

Characteristic Curves

All test conditions are at 25°C The figures are identical for ACF-10S09

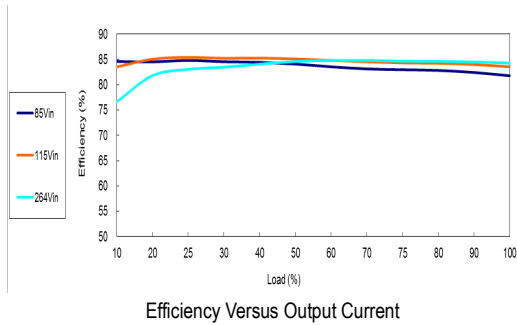

Efficiency Versus Output Current

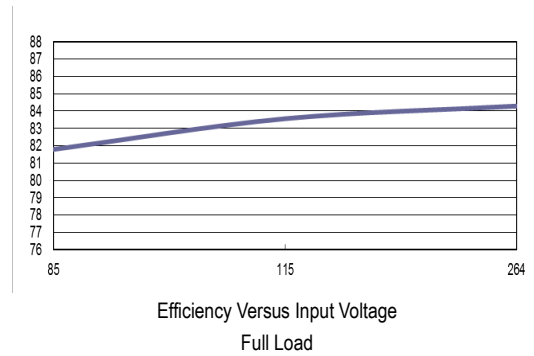

Efficiency Versus Input Voltage Full Load

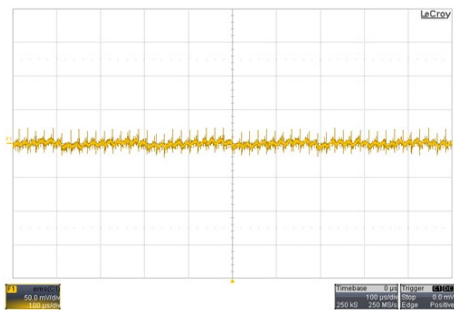

Typical Output Ripple and Noise
 $V_{in}=V_{in\ nom}$; Full Load

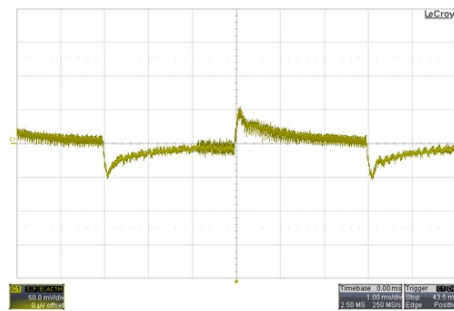

Transient Response to Dynamic Load Change
from 100% to 75% of Full Load ; $V_{in}=V_{in\ nom}$

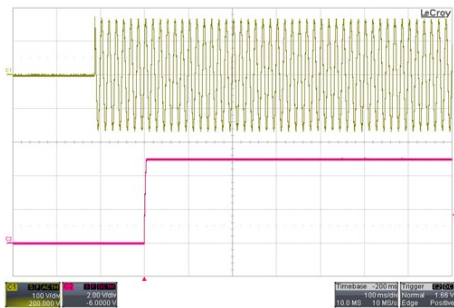

Typical Input Start-Up and Output Rise Characteristic
 $V_{in}=V_{in\ nom}$; Full Load

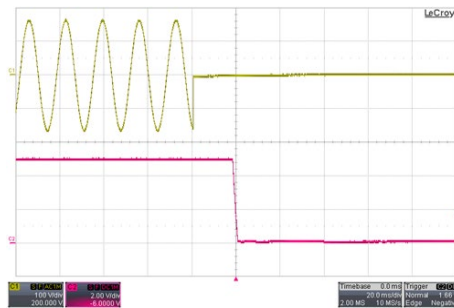

Typical Input Hold-up and Output Rise Characteristic
 $V_{in}=V_{in\ nom}$; Full Load

Characteristic Curves

All test conditions are at 25°C The figures are identical for ACF-10S12

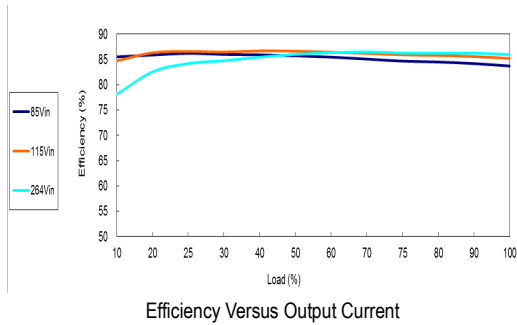

Efficiency Versus Output Current

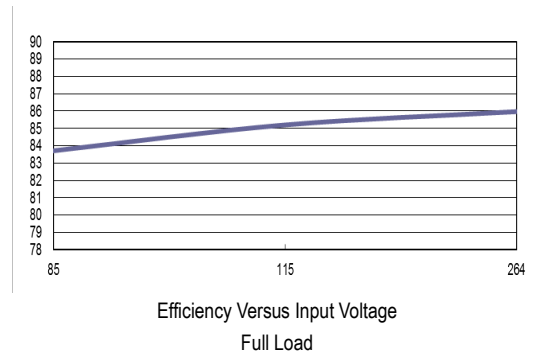

Efficiency Versus Input Voltage Full Load

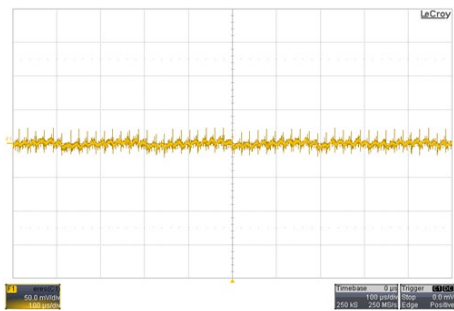

Typical Output Ripple and Noise
 $V_{in}=V_{in\ nom}$; Full Load

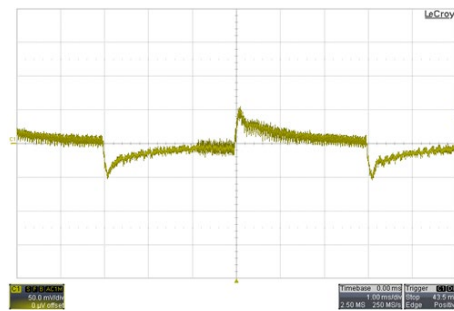

Transient Response to Dynamic Load Change
from 100% to 75% of Full Load ; $V_{in}=V_{in\ nom}$

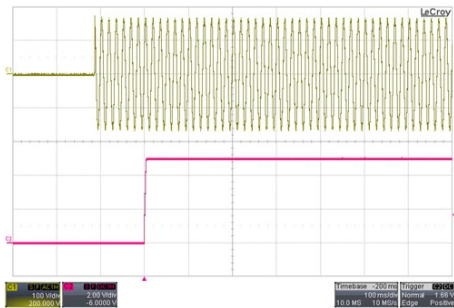

Typical Input Start-Up and Output Rise Characteristic
 $V_{in}=V_{in\ nom}$; Full Load

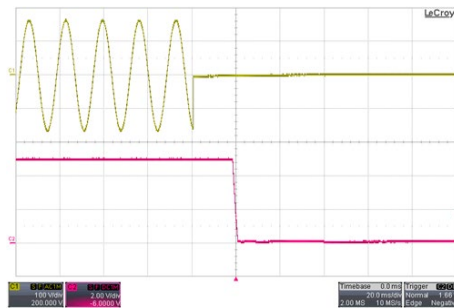

Typical Input Hold-up and Output Rise Characteristic
 $V_{in}=V_{in\ nom}$; Full Load

Characteristic Curves

All test conditions are at 25°C The figures are identical for ACF-10S15

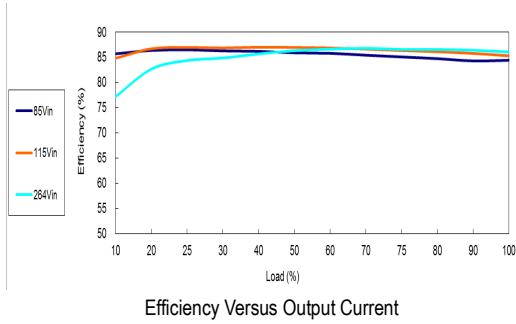

Efficiency Versus Output Current

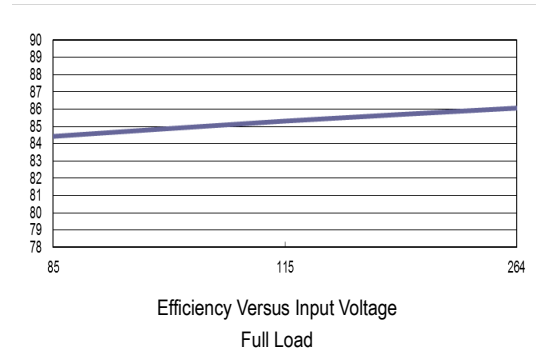

Efficiency Versus Input Voltage Full Load

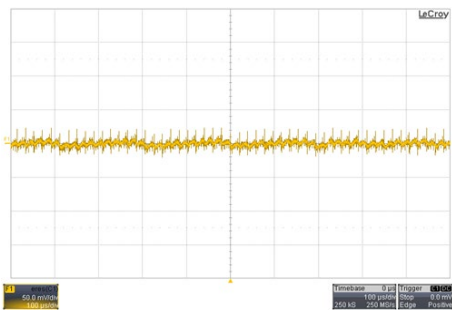

Typical Output Ripple and Noise
 $V_{in}=V_{in\ nom}$; Full Load

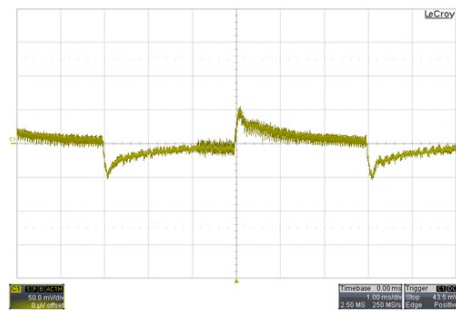

Transient Response to Dynamic Load Change
from 100% to 75% of Full Load ; $V_{in}=V_{in\ nom}$

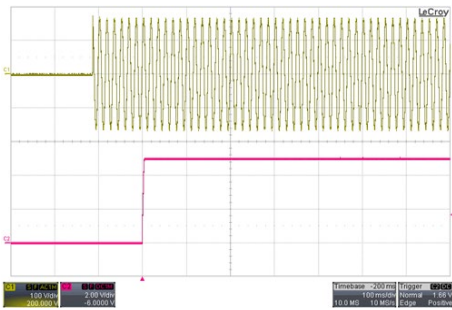

Typical Input Start-Up and Output Rise Characteristic
 $V_{in}=V_{in\ nom}$; Full Load

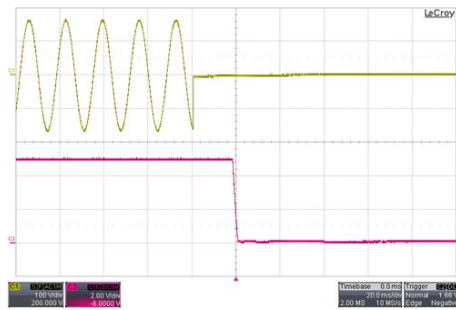

Typical Input Hold-up and Output Rise Characteristic
 $V_{in}=V_{in\ nom}$; Full Load

Characteristic Curves

All test conditions are at 25°C The figures are identical for ACF-10S24

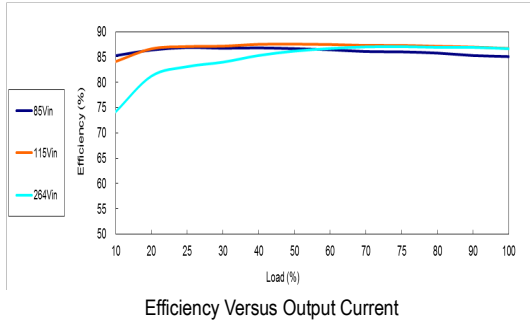

Efficiency Versus Output Current

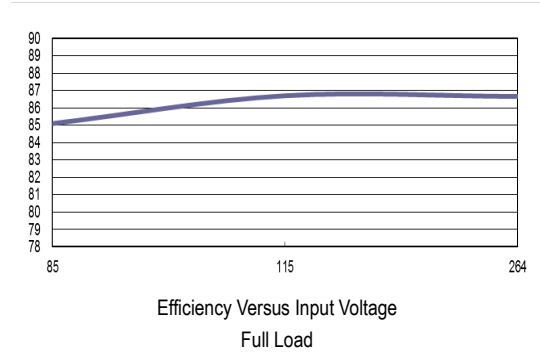

Efficiency Versus Input Voltage Full Load

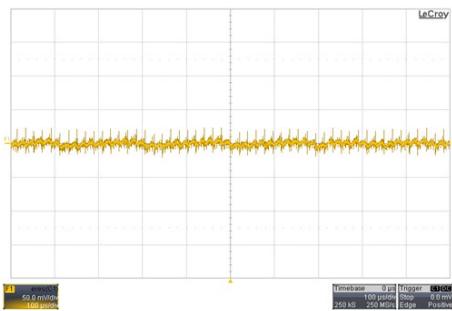

Typical Output Ripple and Noise
 $V_{in}=V_{in\ nom}$; Full Load

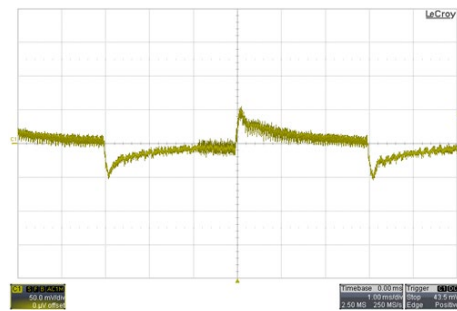

Transient Response to Dynamic Load Change
from 100% to 75% of Full Load ; $V_{in}=V_{in\ nom}$

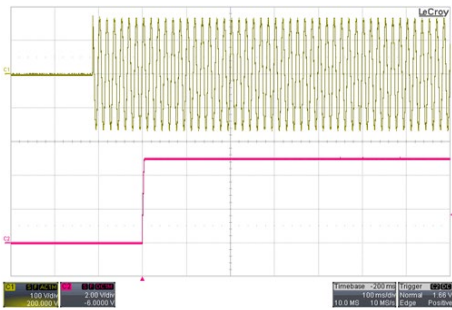

Typical Input Start-Up and Output Rise Characteristic
 $V_{in}=V_{in\ nom}$; Full Load

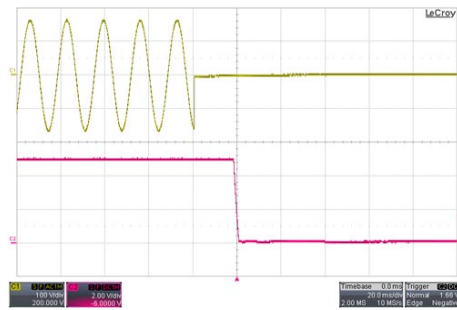

Typical Input Hold-up and Output Rise Characteristic
 $V_{in}=V_{in\ nom}$; Full Load

Characteristic Curves

All test conditions are at 25°C The figures are identical for ACF-10S48

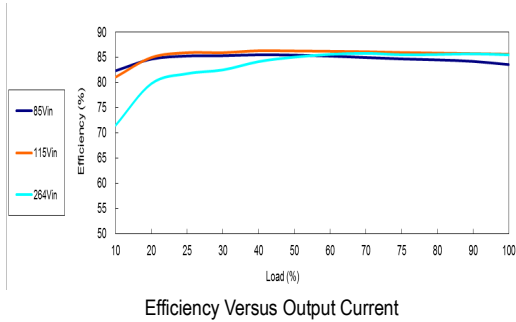

Efficiency Versus Output Current

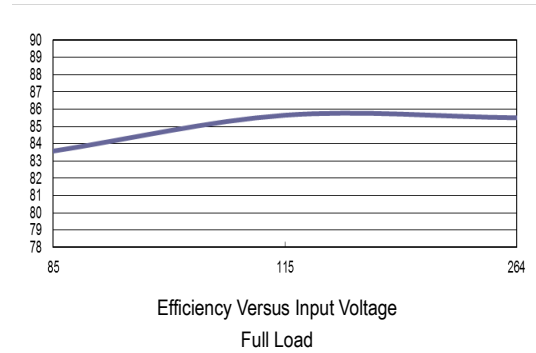

Efficiency Versus Input Voltage Full Load

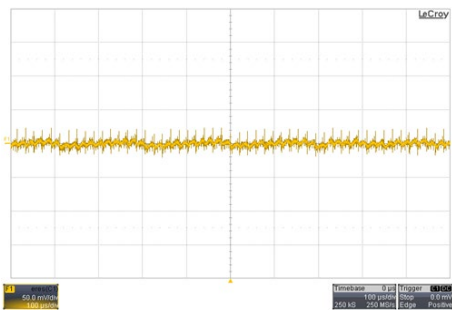

Typical Output Ripple and Noise
 $V_{in}=V_{in\ nom}$; Full Load

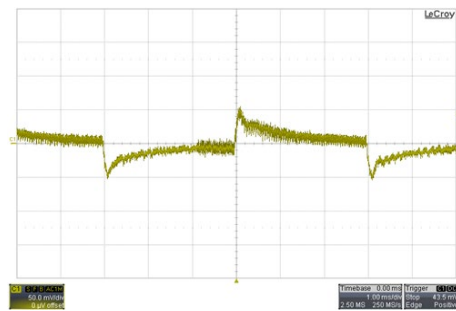

Transient Response to Dynamic Load Change
from 100% to 75% of Full Load ; $V_{in}=V_{in\ nom}$

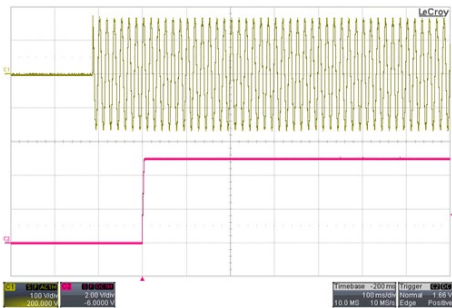

Typical Input Start-Up and Output Rise Characteristic
 $V_{in}=V_{in\ nom}$; Full Load

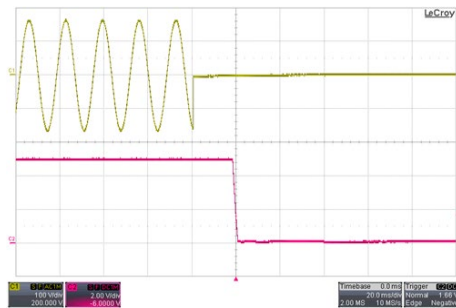

Typical Input Hold-up and Output Rise Characteristic
 $V_{in}=V_{in\ nom}$; Full Load

Package Specifications

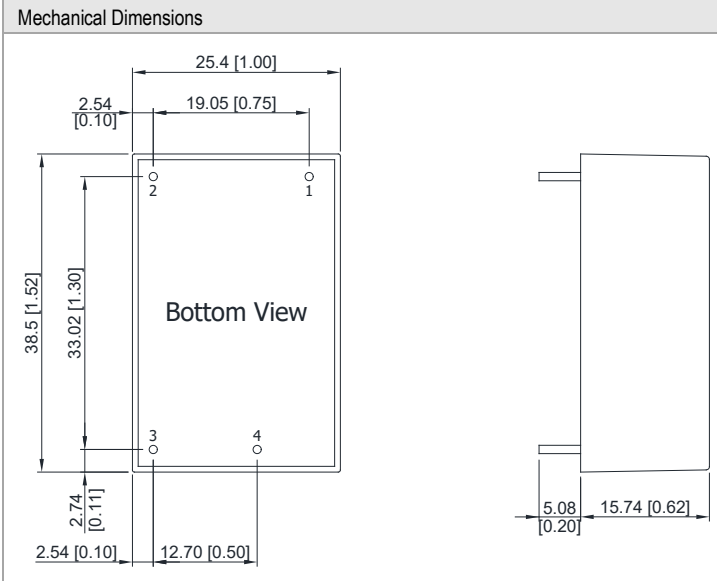

Pin Connections

Pin	Function	Diameter mm (inches)
1	AC(N)	∅ 1.0 [0.04]
2	AC(L)	∅ 1.0 [0.04]
3	-Vout	∅ 1.0 [0.04]
4	+Vout	∅ 1.0 [0.04]

- ▶ All dimensions in mm (inches)
- ▶ Tolerance: ±0.5 (±0.02)
- ▶ Pin pitch tolerance: ±0.25 (±0.01)
- ▶ Pin diameter tolerance: X.X±0.1 (X.XX±0.004)

Physical Characteristics

Case Size	: 38.5x25.4x15.74mm (1.52x1.00x0.62 inches)
Case Material	: Plastic resin (flammability to UL 94V-0 rated)
Pin Material	: Copper Alloy
Weight	: 29g

Recommended Pad Layout

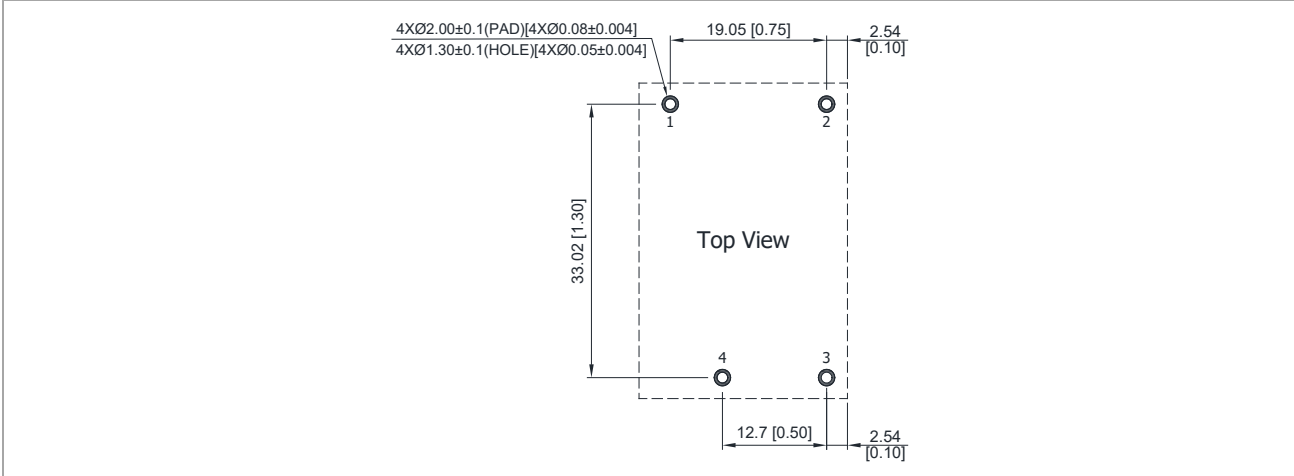

Packaging Information

Tube

Tube

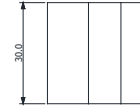
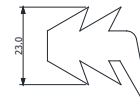
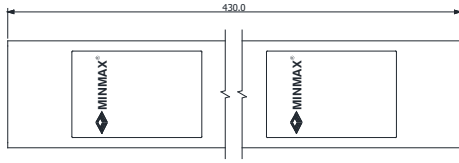
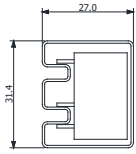

Unit: mm
10 PCS per TUBE

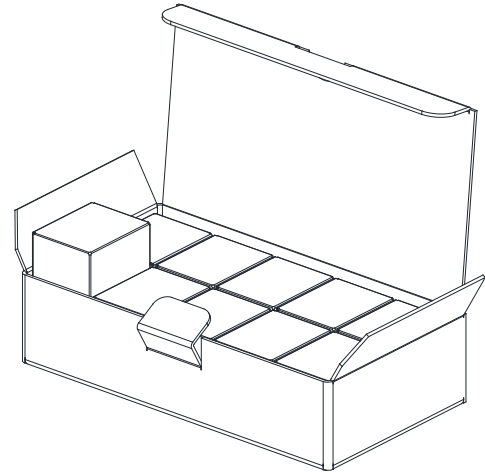
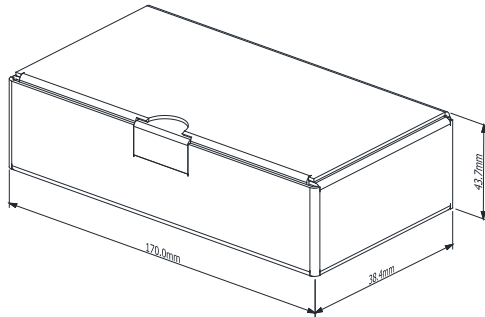
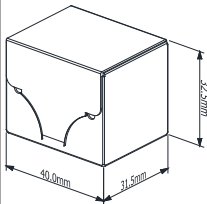

Unit: mm
10 PCS per Box

Wave Soldering Considerations

Lead free wave solder profile

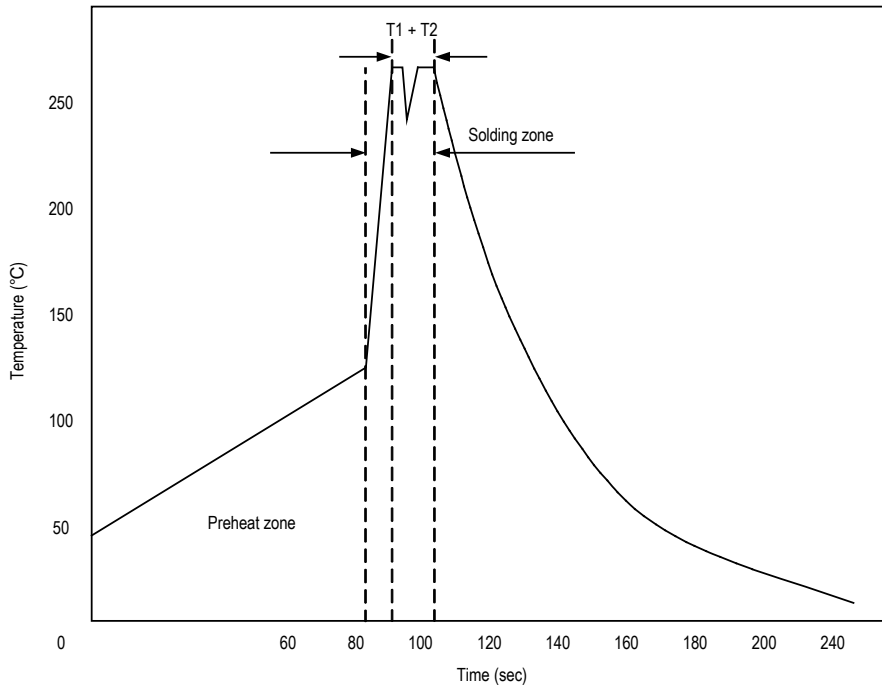

Zone	Reference Parameter
Preheat	Rise temp. speed : 3°C/sec max.
zone	Preheat temp. : 100~130°C
Actual	Peak temp. : 250~260°C
heating	Peak time(T1+T2) : 4~6 sec

Hand Welding Parameter

Reference Solder: Sn-Ag-Cu : Sn-Cu : Sn-Ag

Hand Welding: Soldering iron : Power 60W

Welding Time: 2~4 sec

Temp.: 380~400°C

Part Number Structure

ACF	-	10	S	03																												
		<table border="1"> <tr> <td style="text-align: center;">Output Power</td> </tr> <tr> <td style="text-align: center;">10 Watt</td> </tr> </table>	Output Power	10 Watt	<table border="1"> <tr> <td style="text-align: center;">Output Quantity</td> </tr> <tr> <td style="text-align: center;">S: Single</td> </tr> </table>	Output Quantity	S: Single	<table border="1"> <tr> <td colspan="3" style="text-align: center;">Output Voltage</td> </tr> <tr> <td style="text-align: center;">03:</td> <td style="text-align: center;">3.3</td> <td style="text-align: center;">VDC</td> </tr> <tr> <td style="text-align: center;">05:</td> <td style="text-align: center;">5</td> <td style="text-align: center;">VDC</td> </tr> <tr> <td style="text-align: center;">09:</td> <td style="text-align: center;">9</td> <td style="text-align: center;">VDC</td> </tr> <tr> <td style="text-align: center;">12:</td> <td style="text-align: center;">12</td> <td style="text-align: center;">VDC</td> </tr> <tr> <td style="text-align: center;">15:</td> <td style="text-align: center;">15</td> <td style="text-align: center;">VDC</td> </tr> <tr> <td style="text-align: center;">24:</td> <td style="text-align: center;">24</td> <td style="text-align: center;">VDC</td> </tr> <tr> <td style="text-align: center;">48:</td> <td style="text-align: center;">48</td> <td style="text-align: center;">VDC</td> </tr> </table>	Output Voltage			03:	3.3	VDC	05:	5	VDC	09:	9	VDC	12:	12	VDC	15:	15	VDC	24:	24	VDC	48:	48	VDC
Output Power																																
10 Watt																																
Output Quantity																																
S: Single																																
Output Voltage																																
03:	3.3	VDC																														
05:	5	VDC																														
09:	9	VDC																														
12:	12	VDC																														
15:	15	VDC																														
24:	24	VDC																														
48:	48	VDC																														

MTBF and Reliability

The MTBF of ACF-10 series of AC-DC Power Module has been calculated using

MIL-HDBK 217F NOTICE2, Operating Temperature 25°C, Ground Benign.

Model	MTBF	Unit
ACF-10S03	452,916	Hours
ACF-10S05	469,582	
ACF-10S09	564,573	
ACF-10S12	606,988	
ACF-10S15	604,913	
ACF-10S24	614,998	
ACF-10S48	595,110	